

BROOKFIELD DV1

Digital Viscometer

Operating Instructions

Manual No. **M14-023**

Distributed by:

Lab Unlimited
CARL STUART GROUP

Tallaght Business Park
Whitestown, Dublin 24,
Ireland
D24 RFK3

Tel: (01) 4523432
Fax: (01) 4523967
E-mail: info@labunlimited.com
Web: www.labunlimited.com

Quatro House, Frimley Road,
Camberley,
United Kingdom
GU16 7ER

Tel: 08452 30 40 30
Fax: 08452 30 50 30
E-mail: info@labunlimited.co.uk
Web: www.labunlimited.co.uk



TABLE OF CONTENTS

I. INTRODUCTION	5
I.1 Components	6
I.2 Utilities	7
I.3 Components and Dimensions.....	8
I.4 Specifications.....	10
I.5 Installation	11
I.6 Safety Symbols and Precautions.....	11
I.7 Key Functions.....	12
I.8 Preventative Maintenance and Cleaning.....	13
II. GETTING STARTED	14
II.1 Power Up	14
II.2 AutoZero	14
II.3 Navigation.....	15
II.4 Home Screen	15
II.5 Spindle Selection	15
II.6 Speed Selection	18
II.7 Full Scale Range	19
II.8 Options	20
II.8.1 Run Until.....	20
II.8.2 Test View	21
II.8.3 Visc Units	22
II.8.4 Temp Units.....	22
II.8.5 Tmp. Offset	23
II.8.6 Language	23
II.8.7 Connect	23
II.8.8 Reset.....	23
II.8.9 About.....	23
II.8.10 Service.....	24
II.9 Printing	24
III. Making Viscosity Measurements	26
III.1 Quick Start	26
III.2 Preparation for Making Measurements.....	26
III.3 Selecting a Spindle/Speed	27
III.4 Running a Test.....	27
III.5 Communication with Wingather SQ Software.....	28

Appendix A - Cone/Plate Viscometer Set-Up	31
Appendix B - Viscosity Ranges	36
Appendix C - Variables in Viscosity Measurements	40
Appendix D - Spindle Entry Codes and SMC/SRC Values	42
Appendix E - Spindle Entry Codes and Range Coefficients	45
Appendix F - Calibration Check Procedures	47
Appendix G - The Brookfield Guardleg	54
Appendix H - Laboratory Stands with Parts Identification	56
Appendix I - DVE-50A Probe Clip	58
Appendix J - Fault Diagnosis and Troubleshooting	59
Appendix K - Online Help and Additional Resources	59
Appendix L - Warranty Repair and Services	60
Viscosity Test Report	(tear out page)

I. INTRODUCTION

The Brookfield DV1 Viscometer series has provided exceptional value for viscometer users since its introduction in 1981. Brookfield has continued to develop and improve the DV1 to maintain its position in the market as the best value for Q/C applications. The Brookfield DV1 Viscometer continues in this tradition of innovation, quality and value. The incorporation of a large graphical display and “Hot Keys” has allowed for a new and improved user interface that preserves single speed data collection methods (or multiple speeds when using Wingather SQ), which makes using the DV1 Viscometer easier than ever before.

The Brookfield DV1 Viscometer measures fluid viscosity which is a measure of a fluid’s resistance to flow. You will find a detailed description of the science of viscosity in the Brookfield publication “More Solutions to Sticky Problems”, a copy of which was included with your DV1.

The principle of operation of the DV1 is to drive a spindle (which is immersed in the test fluid) through a calibrated spring. The viscous drag of the fluid against the spindle is measured by the spring deflection. Spring deflection is measured with a rotary transducer. This system provides continuous sensing and display of the measurement during the entire test. The measurement range of a DV1 (in centipoise or milliPascal-seconds) is determined by the rotational speed of the spindle, the size and shape of the spindle, the container the spindle is rotating in, and the full-scale torque of the calibrated spring.

There are four basic spring torque series offered by Brookfield:

<u>Model</u>	<u>Spring Torque</u>	
	<u>dyne•cm</u>	<u>milli Newton•m</u>
DV1MLV	673.7	0.0673
DV1MRV	7,187.0	0.7187
DV1MHA	14,374.0	1.4374
DV1MHB	57,496.0	5.7496

The higher the torque calibration, the higher the measurement range. The viscosity measurement range for each torque calibration may be found in Appendix B.

The DV1 is configured to accept an optional temperature probe, which allows temperature readout over the range -100°C to +300°C (-148°F to + 572°F). This option allows ambient temperature measurement or temperature measurement of the sample during viscosity testing. Contact Brookfield or your local Brookfield dealer for more information on this instrument option.

All units of measurement are displayed according to either the CGS system or the SI system.

1. Viscosity appears in units of centipoise (shown as “cP”) or milliPascal-seconds (shown as mPa•s) on the DV1 Viscometer display.
2. Torque appears in units of dyne-centimeters or Newton-meters (shown as percent “%”) in both cases) on the DV1 Viscometer display.
-  3. Temperature appears in units of Celsius (shown as C) or Fahrenheit (shown as F) on the DV1 Viscometer display.

The following applies to DV1 Viscometers when using an optional temperature probe. Look for the symbol  throughout this manual for instructions pertaining specifically to DV1 Viscometers with temperature probe option.

The equivalent units of measurement in the SI system are calculated using the following conversions:

	<u>SI</u>		<u>CGS</u>
Viscosity:	1 mPa•s	=	1 cP
Torque:	1 Newton•m	=	10 ⁷ dyne•cm

References to viscosity throughout this manual are done in CGS units. The DV1 Viscometer provides equivalent information in SI units.

I.1 Components

COMPONENT	PART NUMBER	QUANTITY
DV1	varies	1
Model G Laboratory Stand	Model G	1
Spindle Set with Case*	varies	1
DV1MLV set of four spindles (#61 through #64)	SSL or SSLK [†]	
DV1MRV set of six spindles (#02 through #07)	SSR or SSRK [†]	
DV1MHA/HB set of six spindles (#02 through #07)	SSH or SSHK [†]	
Shipping Cap*	B-30-3Y	1
Power Cord (115V/230V)	DVP-65/66	1
Guardleg* (not supplied with HA/HB versions)	varies	1
DV1MLV	B-20Y or B20KY [†]	
DV1MRV	B-21Y or B21KY [†]	
Carrying Case	DVE-106	1
Operating Manual	M14-023	1
For cone/plate versions:		
Spindle wrench	CP-23	1
Cone spindle	CPA-XXZ	1
Sample cup	varies	1
Standard	CPA-44YZ	
With embedded temperature probe and cable	CPA-44PYZ	

The following applies to DV1 Viscometers with the temperature probe option. Look for the symbol  throughout this manual for instructions pertaining specifically to DV1 Viscometers with temperature probe option.

OPTIONAL ITEMS

RTD Temperature Probe	DVP-94Y	1
Probe Clip	DVE-50A	1
RTD Cable when supplied with Cone/Plate version	SC4-61Y	1

Please check to be sure that you have received all components and that there is no damage. If you are missing any parts, please notify Brookfield Engineering or your local Brookfield agent immediately. Any shipping damage must be reported to the carrier.

* Not supplied with Cone/Plate version.

† “K” in the part number identifies EZ-Lock spindles.

I.2 Utilities

Input Voltage: 115 VAC or 230 VAC
Input Frequency: 50/60 Hz
Power Consumption: 50 VA

Power Cord Color Code:

	United States	Outside United States
Hot (live)	Black	Brown
Neutral	White	Blue
Ground (earth)	Green	Green/Yellow

I.3 Components and Dimensions

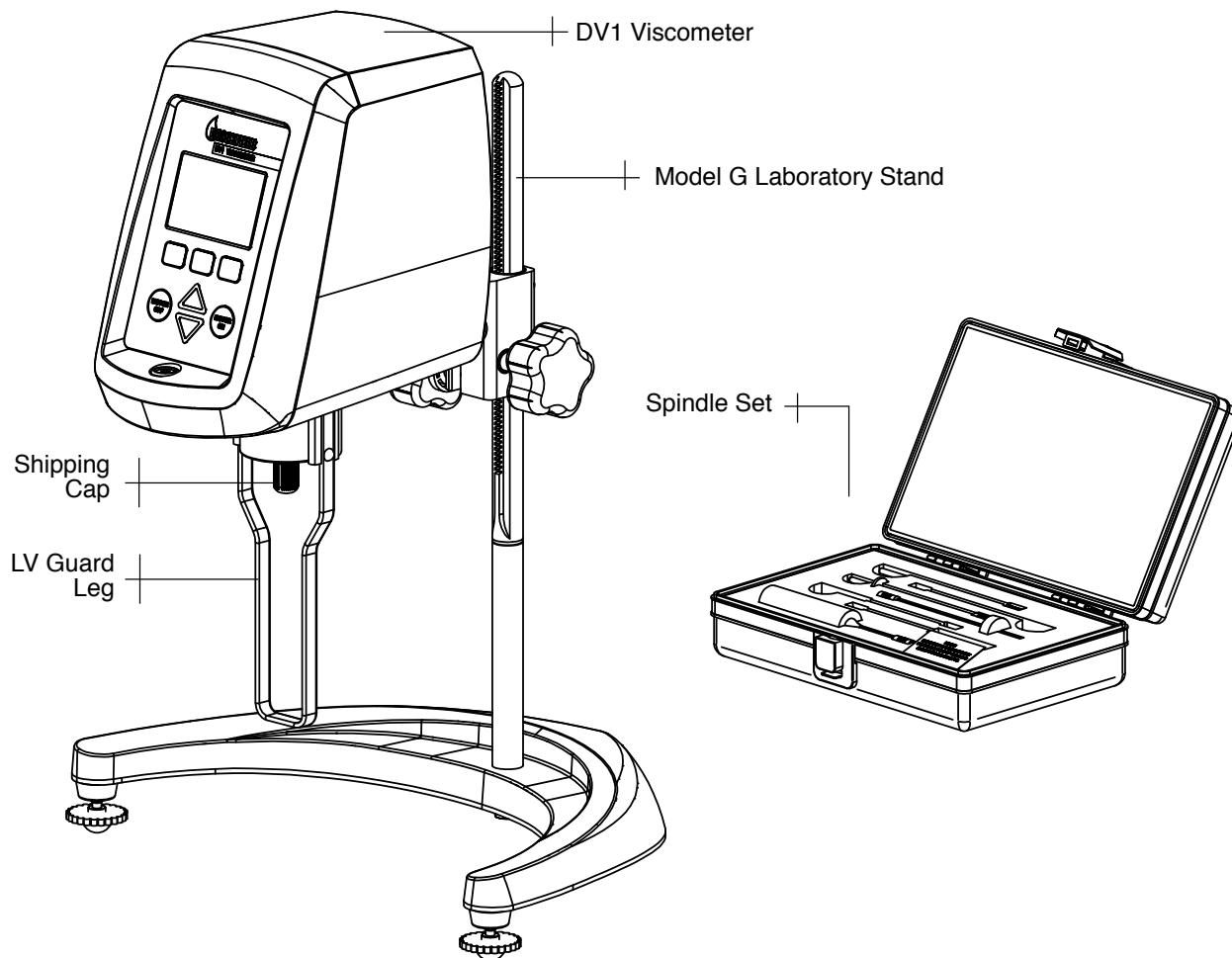

Cone/Plate Option

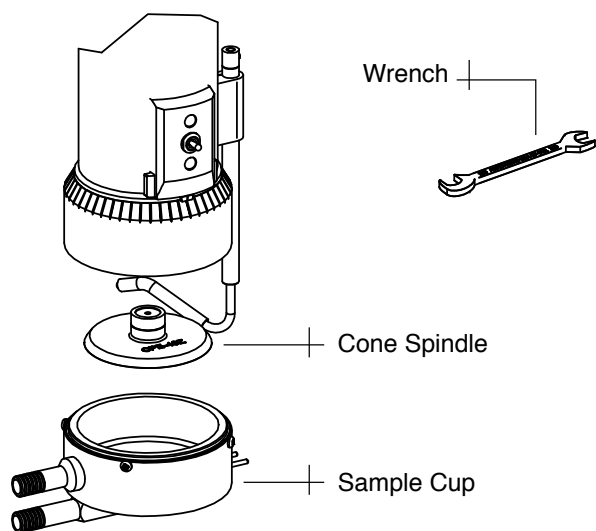

Temperature Probe Option

- *For use with SSA or C/P:*

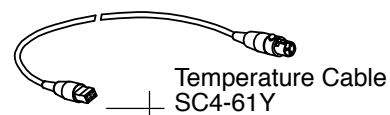

- *For use in beaker:*

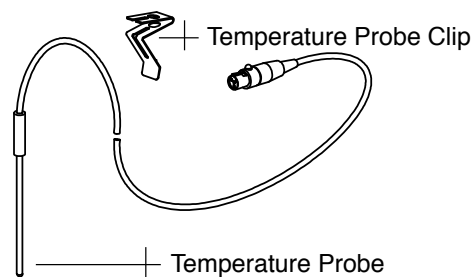

Figure I-1

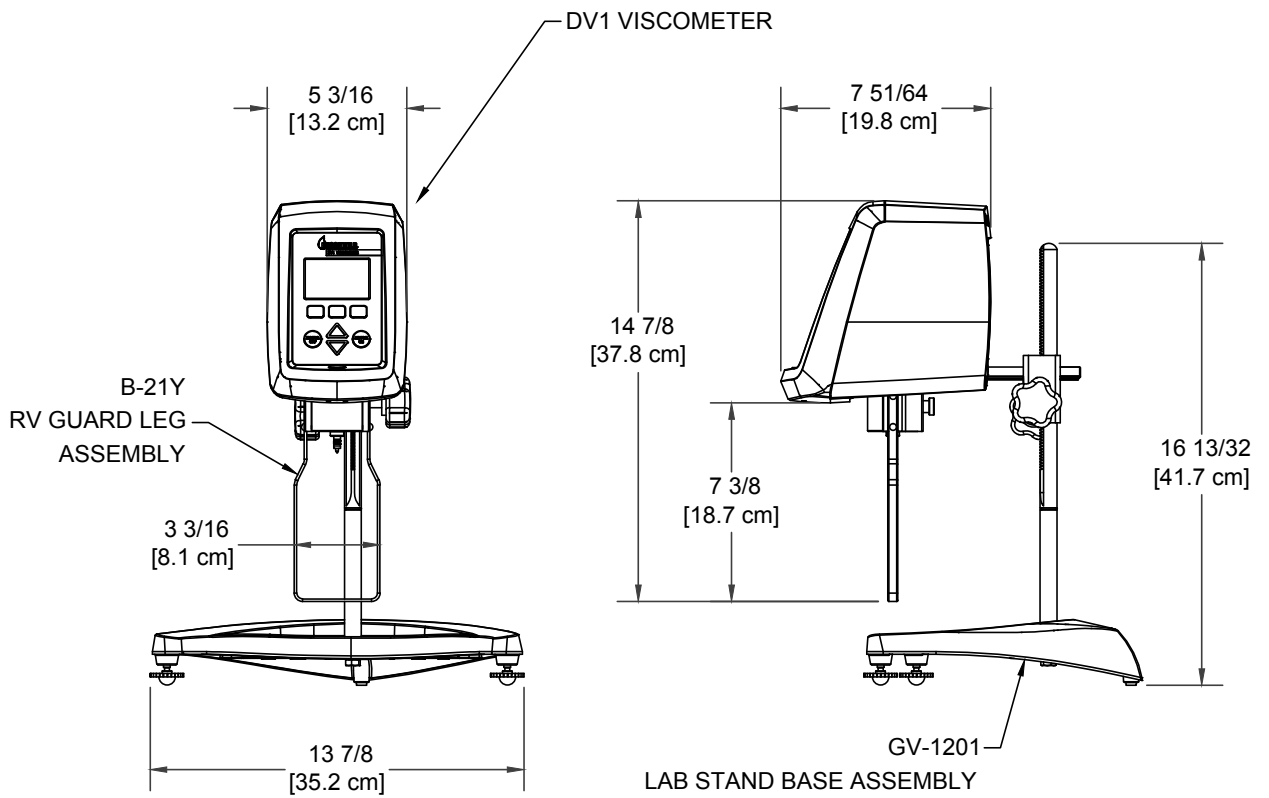
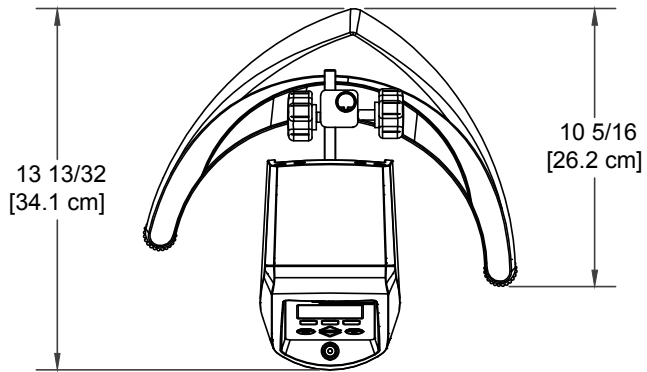



Figure I-2

I.4 Specifications

Speeds: (rpm)	0.0, 0.3, 0.6, 1.5, 3, 6, 12, 30, 60, 0.5, 1, 2, 2.5, 4, 5, 10, 20, 50, 100
Weight:	Gross Weight: 20 lb 9 kg
	Net Weight: 17 lb 7.7 kg
	Carton Volume: 1.65 cu ft 0.05 m ³
Operating Environment:	0°C to 40°C Temperature Range (32°F to 104°F) 20% - 80% R.H.: non-condensing atmosphere
Viscosity Accuracy:	±1.0% Full Scale Range in Use (See Appendix D for range calculation)
Viscosity Repeatability:	±0.2% of Full Scale Range in Use
 Temperature Sensing Range:	-100°C to +300°C (-148°F to +572°F)
 Temperature Accuracy:	±1°C: -100°C to +149°C ±2°C: +150°C to +300°C

Electrical Certifications:

Conforms to CE Standards:

BSEN 61326: Electrical equipment for measurement, control and laboratory use - EMC requirements.

BSEN 61010-1: Safety requirements for electrical equipment, for measurement, control and laboratory use.

Notice to customers:



This symbol indicates that this product is to be recycled at an appropriate collection center.

Users within the European Union:

Please contact your dealer or the local authorities in charge of waste management on how to dispose of this product properly. All Brookfield offices and our network of representatives and dealers can be found on our website: www.brookfieldengineering.com

Users outside of the European Union:

Please dispose of this product according to your local laws.

I.5 Installation

Note: “IQ, OQ, PQ”, an abbreviated guideline document for installation, operation and performance validation for your DV1 digital viscometer can be downloaded from our website www.brookfieldengineering.com. A more detailed IQ,OQ,PQ procedure is available for purchase from Brookfield or your authorized dealer.

- 1) Assemble the Model G Laboratory Stand (refer to assembly instructions in Appendix H).
- 2) Attach the viscometer head to the clamp on the lab stand rod.
-  3) Connect the RTD probe to the socket on the rear panel of the DV1.
- 4) The Viscometer must be leveled. The level is adjusted using the two leveling screws on the base. Adjust the leveling screws so that the bubble level on the front of the DV1 is centered within the circle.

Note: Check level periodically during use.

- 5) Remove the shipping cap which secures the coupling nut on the Viscometer to the pivot cup. For Cone/Plate Models, hold the Sample Cup and swing the tension bar away from the bottom of the cup. Lower the cup and remove the foam insert. (Save for future shipments.)
- 6) Optional: Install the screen protector per the instructions on the package. Additional installation help can also be found on our YouTube channel: www.youtube.com/user/BrookfieldEng

Refer to Figure I-2 for the following, except where noted.

- 7) Make sure that the AC power switch at the rear of the DV1 is in the OFF position. Connect the power cord to the socket on the back panel of the instrument and plug it into the appropriate AC line. For Cone/Plate Models, be sure that the toggle switch, used to activate the electronic gap, is to the left position. (Left when facing the viscometer.)



Note: The DV1 must be earth grounded to ensure against electronic failure!!



Note: The AC input voltage and frequency must be within the appropriate range as shown on the nameplate of the viscometer (see Section I.2).

- 8) Turn the power switch to the ON position and allow the viscometer to warm up for 10 minutes before performing autozero.
- 9) For Cone/Plate models, refer to Appendix A.
- 10) If appropriate, connect the USB cable (DVP-202) to the USB B port for connection of the DV1 to the PC.
- 11) If using the optional Dymo Label Writer 450, connect the cable supplied with the printer to the USB A port.

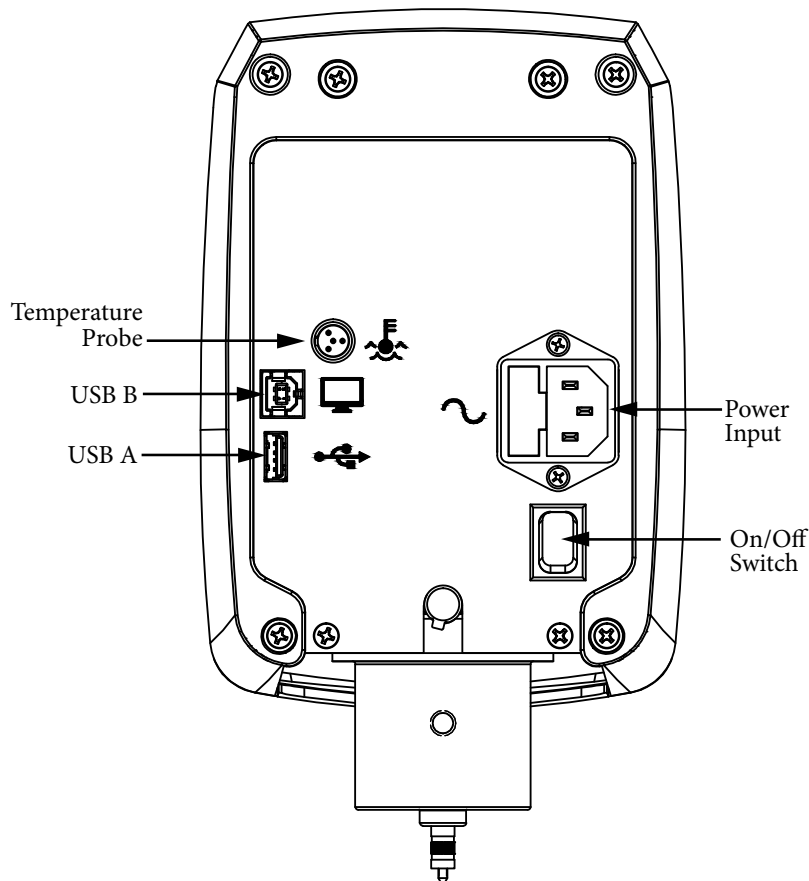

Figure I-2

I.7 Key Functions

Figure I-3 shows the control keys on the face of the DV1 Viscometer. The following describes each key's function.



HOT KEY

Three **Hot Keys** are located immediately below the display. The action executed by the hot key will be indicated on the display. The actions available will vary with each screen. Typical actions include:

BACK:	Return to previous screen
SELECT:	Accept the parameter entered/chosen
HOME:	Return to the Home screen
SPINDLE:	Enter Spindle Selection screen
SPEED:	Enter Speed Selection screen
OPTIONS:	Enter Options screen
PRINT:	Print test data
NEXT:	Advance to the next screen



MOTOR OFF

This key is used to turn the motor off, stop spindle rotation and stop current test.

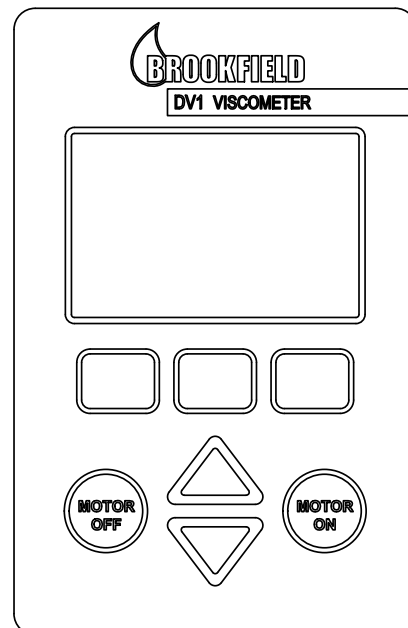

Figure I-3



MOTOR ON

This key is used to turn the motor on, start spindle rotation and start current test.



UP ARROW

This key is used to **Scroll Up** (in an increasing value direction) through the available speed or spindle tables.



DOWN ARROW

This key is used to **Scroll Down** (in a decreasing value direction) through the available speed or spindle tables.

I.8 Preventative Maintenance and Cleaning



Make sure the instrument is in a clean, dry working environment (dust-free, moderate temperature, low humidity, etc.)



Make sure the instrument is on a level surface.



Hands/fingers must be clean and free of residual sample. Not doing so may result in deposit build up on the upper part of the shaft and cause interference between the shaft and the pivot cup.



Be sure to remove spindle from the instrument prior to cleaning. Note left-hand thread. Severe instrument damage may result if spindle is cleaned in place.

Instrument, Keypad and Display: When not using the keypad protector, clean with dry, non-abrasive cloth. Do not use solvents or cleaners.

Immersed Components: Spindles and guard leg are made of stainless steel. Clean with non-abrasive cloth and solvent appropriate for sample material that is not aggressive to stainless steel.



When cleaning spindles, do not apply excessive force, which may result in bending the spindle shaft.

II. GETTING STARTED

II.1 Power Up

The DV1 Viscometer will go through a Power Up sequence when the power is turned on. The viscometer will present a blue screen for approximately 4 seconds and then the About Screen for 5 seconds. The About Screen is shown below and includes several critical parameters about the viscometer including: viscometer torque (LV, RV, HA, HB, or other), and the firmware version number.



Figure II-1

The About Screen can also be accessed through the Options Menu (see Section II.8)

The DV1 Viscometer will automatically transition from the About Screen to the AutoZero Screen.

TIP: When contacting Brookfield or your authorized Brookfield dealer for technical support or repair services, please record the information on the About Screen and the serial number (found on the serial tag located on the back of the instrument head) in any correspondence or shipping paperwork.

II.2 AutoZero

The DV1 Viscometer must perform an AutoZero prior to making viscosity measurements. This process sets the zero reading for the measurement system. The AutoZero will be performed every time the instrument is turned on. It is not necessary to perform an AutoZero before each test.

Proper AutoZero function requires that the viscometer be level (see Section I.5) and that the spindle be removed from the coupling shaft. Additionally, any spindle coupling or extension links used with accessory devices should be removed from the coupling shaft. The DV1 display presents a reminder screen to remove the spindle. The operator must press the NEXT hot key (see Section II.3) to initiate the AutoZero. Upon completion, the DV1 presents a reminder to re-attach the spindle. The operator must press the NEXT hot key to proceed.

TIP: Do not touch the viscometer during the AutoZero process to ensure the best zero value.

TIP: The AutoZero sets the zero point of the viscometer range. A failure to properly level the viscometer or to remove the spindle may affect the zero value and all measurement results.

II.3 Navigation

The DV1 Viscometer uses a 3-inch monochromatic display with keypad. All user input is made through the keypad. See Section I.7 for a description of Key Functions.

Hot Keys are used on the DV1 Viscometer to assist with menu navigation. There are three Hot Keys located immediately under the viscometer display. The function of each key is indicated at the bottom of the display and may change depending on the screen currently in view. The use of Hot Keys allows the DV1 Viscometer to offer many menu choices while using a simple interface. Possible Hot Key actions include:

- NEXT:** Proceed to the next screen.
- BACK:** Return to the previous screen.
- HOME:** Return to the Home screen.
- SPINDLE:** Enter spindle selection screen.
- SPEED:** Enter speed selection screen.
- SELECT:** Choose the currently displayed condition.
May also advance to the next screen.
- PRINT:** Print currently displayed data.

II.4 Home Screen

The DV1 Home screen is presented at the conclusion of AutoZero and can be accessed by selecting a Hot Key marked as HOME. The Home screen shows the measurement parameters chosen by the operator including: measured viscosity, temperature, %torque, motor status, spindle, and speed. The available Hot Keys on the Home screen include: SPINDLE, OPTIONS, and SPEED (see Figure II-2).



Figure II-2

II.5 Spindle Selection

DV1MLV Viscometers are provided with a set of four spindles and a narrow guardleg; DV1MRV Viscometers are provided with a set of six spindles and a wider guardleg; DV1MHA and DV1MHB Viscometers come with a set of six spindles and no guardleg (see Appendix F for more information on the guardleg).

The spindles are attached to the viscometer by screwing them onto the coupling nut on the lower shaft (see Figure II-3). Note that the spindles have a left-hand thread. The lower shaft should be secured and slightly lifted with one hand while screwing the spindle to the left. The face of the spindle nut and the matching surface on the lower shaft should be smooth and clean to prevent eccentric rotation of the spindle. Spindles can be identified by the number on the side of the spindle coupling nut.



The motor should be OFF whenever spindles are being removed or attached.

If your instrument has the EZ-Lock system, the spindles are attached as follows:

With one hand, hold the spindle, while gently raising the spring-loaded outer sleeve to its highest position with the other hand, as shown in Figure II-4. Insert the EZ-Lock Spindle Coupling so that the bottom of the coupling is flush with the bottom of the shaft, and lower the sleeve. The sleeve should easily slide back down to hold the spindle/coupling assembly in place for use. [Spindles can be identified by entry code; look for the number on the side of the EZ-Lock spindle coupling.]

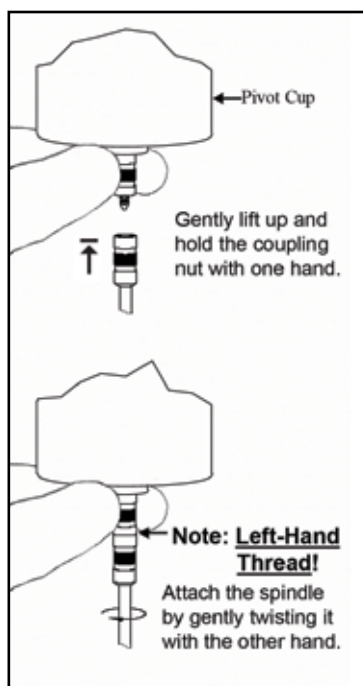

Figure II-3

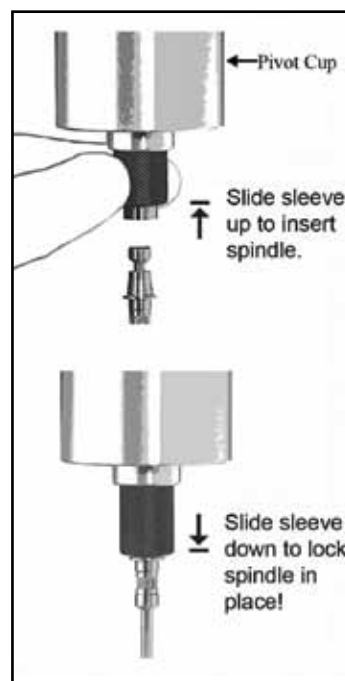

Figure II-4



The motor should be OFF whenever spindles are being removed or attached.

NOTE: Keep the EZ-Lock Spindle Coupling and outer sleeve as clean as possible and free from debris that could become lodged inside the adapter.

The DV1 requires a Spindle Entry Code number to calculate viscosity values. The two-digit code for each spindle can be found in Appendix D.

Pressing the SPINDLE Hot Key on the Home screen will present the Set Spindle screen.



Figure II-5

Press the Up/Down Arrow keys to scroll through the list of available spindles. When the correct spindle number is shown on the display, press the SELECT Hot Key. The display will return to the Home screen.

The Set Spindle screen also includes the currently selected speed of rotation and the Full Scale Range of viscosity (FSR). The FSR represents the maximum viscosity value that can be measured with the currently selected spindle and speed combination. As the spindle number is changed, the FSR value will change to show the new condition. Each spindle and speed combination has a unique FSR.

TIP: The minimum viscosity measurement range is 10% of the FSR.

TIP: Full Scale Range is the same value as AutoRange.

TIP: The accuracy of viscometer measurement is expressed as a percentage of the Full Scale Range.

The Set Spindle screen includes three Hot Keys:

- BACK:** Return to the Home screen without changing the spindle selection.
- SELECT:** Accept the spindle selection and return to the Home screen.
- SPEED:** Accept the spindle selection and move to the Set Speed screen.

II.6 Speed Selection

Table II-1 shows the available speed selections.

DV1 SPEEDS SETS	
	100
	50
	20
	10
	5.0
	4.0
	2.5
	2.0
	1.0
	0.5
	0.0
	60
	30
	12
6.0	
3.0	
1.5	
0.6	
0.3	
Beginning	0.0

Table II-1

NOTE: DV1 speeds are organized to conform to the historical speed sets available on the Brookfield Dial Reading viscometer. Speeds from 0.3-60 RPM are traditionally found on the LVT viscometer. Speeds from 0.5-100 RPM are traditionally found on RVT, HAT and HBT viscometers.

Pressing the SPEED Hot Key on the Home screen will present the Set Speed screen.



Figure II-6

Press the Up/Down Arrow keys to scroll through the list of available speeds. When the correct speed is shown on the display, press the SELECT Hot Key. The display will return to the Home screen.

TIP: Speeds are grouped according to traditional LV and RV settings.

TIP: When setting a test procedure, be aware if the data must be compared to another site. If a comparison is required, it is best to utilize speeds that are traditionally associated with the torque range of the viscometer. This will ensure that all test sites will be able to reproduce the test method exactly.

The Set Speed screen also includes the currently selected spindle and the Full Scale Range of viscosity (FSR). The FSR represents the maximum viscosity value that can be measured with the currently selected spindle and speed combination. As the speed is changed, the FSR value will change to reflect the new condition. Each spindle and speed combination has a unique FSR.

TIP: The minimum viscosity measurement range is 10% of the FSR.

TIP: Full Scale Range is the same value as AutoRange.

TIP: The accuracy of viscometer measurement is expressed as a percentage of the Full Scale Range.

The Set Speed screen include three Hot Keys:

BACK: Return to the Home screen without changing the speed selection.

SELECT: Accept the speed selection and return to the Home screen.

SPEED: Accept the speed selection and move to the Set Spindle screen.

II.7 Full Scale Range

The Full Scale Range (FSR) is a calculation of the maximum viscosity value that can be measured by a spindle and speed combination when used with the specific spring torque of the DV1 Viscometer. This value represents the measured viscosity which will be displayed when the instrument's %torque reading is at 100. The FSR will be displayed during the spindle selection process and the speed selection process. The FSR value will change as the selected speed or spindle is changed and will be displayed in the viscosity measurement units selected by the user in the Options Menu (see Section II.8).

Brookfield recommends that viscosity measurements be made only when the instrument's %torque value is between 10 and 100. The FSR represents the maximum value that can be measured (100% on the Torque scale). The minimum viscosity that can be measured is 10% of the FSR (equivalent to 10 on the Torque scale).

The accuracy of the Brookfield viscometer is expressed as a percentage of the instrument's Full Scale Range. When using the standard LV (61-64) and RV (2-7) spindles, the instrument's accuracy is +/-1% of the Full Scale Range (see Section I.4).

II.8 Options

The Options Menu is accessed from the Home screen by pressing the OPTIONS Hot Key. Use the Arrow Keys to select from the following functions:

- **RUN UNTIL** Set the end condition for the test: Time, Torque or Temperature.
- **SERVICE** No user access.
- **ABOUT** Display start up screen with viscometer torque and firmware version number.
- **LANGUAGE** Choose from available languages.
- **TMP. OFFSET** Set an offset value for the DVP-94Y temperature probe (optional).
- **TEMP. UNITS** Set the unit of temperature measurement.
- **VISC. UNITS** Set the unit of viscosity measurement.
- **TEST VIEW** Set the primary display parameter and the mode of data display.

II.8.1 Run Until

The DV1 Viscometer provides an end condition for the viscosity measurement. The end condition defines when the spindle will stop its rotation and a final data point will be shown on the display. The end condition currently in use on the DV1 can be identified by choosing RUN UNTIL in the Options Menu. The end condition will be displayed on the screen along with the parameter value. End conditions are defined in the table below:

End Condition	Display Name	Parameter	Range
Time	Time	Hours : Minutes : Seconds	00 hours : 00 minutes : 00 seconds to 99 hours : 99 minutes : 59 seconds
Torque	Torq.	% Torque	0 - 100
Temperature	Temp.	Degrees and Tolerance	-100° - 300°C +/-5.0°C

Press the SELECT Hot Key while viewing the Run Until Options screen. This will present the Run Until screen with the currently selected End Condition name underlined. Use the Arrow Keys to change the End Condition selection. Three Hot Keys are available:

- BACK:** Exit the Run Until Options screen and return to the Options Menu.
- SELECT:** Accept the currently underlined End Condition and advance to the Run Until parameter entry screen.
- HOME:** Return to the Home screen.

Run Until Time requires that a time value be selected. Time is entered by first selecting hours (from 00 to 99) then minutes (from 00 to 99) and then seconds (from 00 to 59). Use the Arrow Keys to adjust each parameter. Use the SELECT Hot Key to move from hours to minutes to seconds. Use the BACK Hot Key to move back from seconds to minutes to hours. The time value is accepted by pressing the SELECT Hot Key while on the seconds display.

TIP: Be sure to select a time value that provides sufficient time to allow for equilibrium of the torque sensor. A short time value may result in erroneous data if the torque sensor has not achieved a stable deflection for the measurement condition. Brookfield recommends a minimum time value of 20 seconds. However, this can be reduced based on user judgement by observing when the torque stabilizes.

TIP: Slow speeds require longer time for equilibrium of the measurement sensor. When using speed values less than 5 RPM, consider a time value of 60 seconds or longer.

The DV1 Viscometer can be set to infinite time by choosing Time as the end condition and setting the time value to zero; 00 Hours : 00 Minutes : 00 Seconds. In this configuration, the test will run continuously until the operator presses the Motor Off button.

Run Until Torq. requires that a % Torque value be selected. % Torque is adjusted by using the Arrow Keys. The measured viscosity at the defined % Torque (based on the selected spindle and speed) will also be displayed. The Torq. value is accepted by pressing the SELECT Hot Key. Brookfield recommends that data be collected between 10 - 100% Torque. Data collected at less than 10% is not guaranteed to be accurate to the stated instrument accuracy (see Section I.4).

TIP: When measuring low viscosity materials at high speeds of rotation, the beginning of the test may include large swings in measured torque. Such swings in torque could cause the Torq. end condition to be met and result in the premature end of the test.

Run Until Temp. requires that a temperature value and tolerance value be selected. Temperature will be entered in units of C or F as defined by the user (see Section II.8). Temperature and Tolerance are adjusted by using the Arrow Keys. The SELECT Hot Key is used to advance from Temperature to Tolerance and finally to accept the input values. The BACK Hot Key can be used to move back from Tolerance to Temperature.

The Tolerance value provides flexibility in the test method. The temperature measurement system of the DV1 Viscometer utilizes a Brookfield DVP-94Y temperature probe which has an accuracy of $\pm 1.0^{\circ}\text{C}$ in the range of -100° to 150°C . The accuracy value could result in a measured/displayed temperature which is not exactly equal to the set Temperature for the Run Until Temp. end condition. For example, if the temperature probe is placed in a water bath that is set to rise to 50°C , the DV1 Viscometer may display 49.5°C when the temperature bath is at thermal equilibrium. Since the accuracy of temperature measurement is $\pm 1^{\circ}\text{C}$, this result is considered correct. However, if the Run Until Temp. end condition is set to 50.0°C , then the test condition will never be met. The tolerance value allows the instrument to consider the end point achieved when the measured temperature is within the specified amount of the set point. For example; the Temperature end condition is set to 50.0°C and the tolerance is set to $\pm 1.0^{\circ}\text{C}$. When the measured temperature reaches 49.0°C , the end condition will then be met and the test will stop.

TIP: Brookfield recommends that the Tolerance value be set to 0.2°C or higher for every Run Until Temp. end condition.

II.8.2 Test View

The DV1 Viscometer provides the user with two controls for the configuration of the Home Screen. Examples of TEST VIEW settings are as follows:

1. The user can choose which parameter is displayed on the top line of the display (the primary parameter). This value will use the largest font size possible. The primary parameter can be set to any of the following: Viscosity, Time, Temperature, and Torque. The remaining parameters will be displayed in a smaller font on the second and third lines of the display.
2. The user can choose the mode of how the remaining parameters are viewed, either Static or Variable.

The Static selection will present a fixed display with all parameters shown simultaneously on the top three lines of the display. Figure II-7 is an example of a test in progress showing the

time clock as it counts down to 00:00:00.

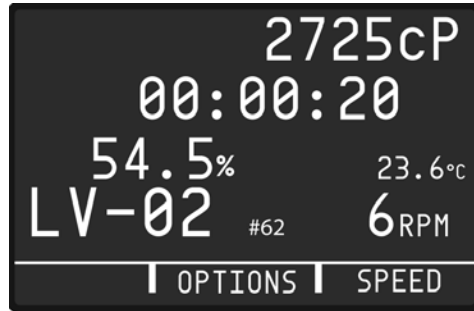

Figure II-7

The Variable selection will present the primary parameter on the top line and the remaining parameters will be presented in succession on the second line. Each parameter on the second line will be displayed for 2 seconds. Figure II-8 shows the active test screen with Time presented on the second line waiting for %Torque and then Temperature.

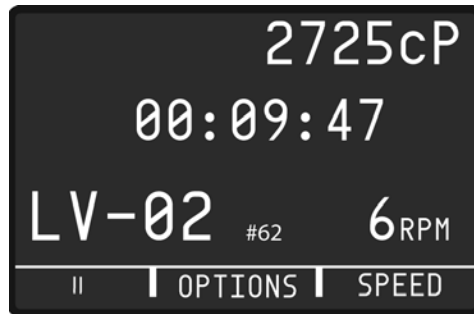

Figure II-8

II.8.3 Visc Units

The units of viscosity display can be configured as defined in the table below.

Unit Abbreviation	Unit	Equivalency
cP	Centipoise	100 cP = 1 P = 100 mPAS = 0.1 PAS
PAS	Pascal Second	1 PAS = 1000 mPAS = 1000 cP = 10 P
mPAS	Millipascal Second	1 mPAS = 1 cP = 0.01 P = 0.001 PAS
P	Poise	1 P = 100 cP = 100 mPAS = 0.1 PAS

VISC UNITS screen in the Options Menu displays the currently set viscosity units. The factory setting is cP. To change the VISC UNITS value, press the SELECT Hot Key and then use the Arrow Keys to scroll to the required value. Press the SELECT Hot Key to accept the change. Press the BACK or HOME Hot Key to cancel any change.

II.8.4 Temp Units

The units of temperature display can be configured to either Celsius (C) or Fahrenheit (F). **TEMP UNITS** screen in the Options Menu displays the currently set temperature units. The factory setting is C. To change the TEMP UNITS value, press the SELECT Hot Key and then use the Arrow Keys

to scroll to the required value. Press the SELECT Hot Key to accept the change. Press the BACK or HOME Hot Key to cancel any change.

II.8.5 Tmp. Offset

The DV1 Viscometer supports the use of an offset for the temperature measurement through the DVP-94Y temperature probe. The Brookfield DVP-94Y temperature probe has an accuracy of +/- 1.0°C in the range of -100° to 149.9°C and +/-2.0°C in the range of 150° to 300°C. An offset may be entered into the DV1 to adjust the temperature reading to be in agreement with a third party measurement device. The offset can be set to any value between -5.0° to 5.0°C or -9.0° to 9.0°F.

TIP: The determination of a temperature offset requires the use of a third party calibrated temperature probe. Be sure to allow for proper thermal equilibrium between the DVP-94Y Brookfield probe and the third party probe.

The **TMP. OFFSET** screen in the Options Menu displays the current offset value. The factory setting is 0.0°C. To change the TMP. Offset value, press the SELECT Hot Key and then use the Arrow Keys to scroll to the required number. Press the SELECT Hot Key to accept the change. Press the BACK or HOME Hot Key to cancel any change.

II.8.6 Language

The DV1 Viscometer supports several languages for the instrument display. Available languages include: Chinese, English, French, German, Japanese, Portuguese, Spanish, and Russian. The Language screen in the Options Menu displays the currently selected Language. To select a new language, press the SELECT Hot Key and then use the Arrow Keys to scroll through the list of available languages. Press the SELECT Hot Key to accept the language choice. The screen will return to the Options Menu with the newly selected language indicated.

II.8.7 Connect

The Connect function resets the USB A (printer) and the USB A (computer) communication port. Use this function to trouble shoot any performance issue when trying to print to the Dymo printer or communicate with Brookfield Wingather SQ software.

The Connect screen in the Options Menu displays a reminder to check the cable connections as the first step in trouble shooting. Once the SELECT Hot Key is pressed, the DV1 will take several seconds to reset the ports and then a message will be displayed indicating that the function is complete. Press the HOME Hot Key to return to the main screen.

II.8.8 Reset

The Reset function will return all user set parameters (except spindle and speed) to the factory default settings. The Reset screen in the Options Menu indicates the reset action. Press the SELECT Hot Key to initiate the reset function. Upon completion of the reset function, the display will be set to the About Options screen (Section II.8.9).

TIP: The Reset function cannot be reversed.

II.8.9 About

The **About** screen presents the information seen on the start up screen including Viscometer Name, Viscometer Model (LV, RV, HA, HB or other) and the firmware version of the viscometer operating system.

TIP: When contacting Brookfield for service/support, note the information from the About Screen and have the instrument serial number available (found on the serial tag located on the back of the instrument head).

The About screen also provides a collection of instrument check values that can assist Brookfield with troubleshooting. Pressing the NEXT Hot Key will advance the About screen through two additional screens with data. You may be asked to provide some of these check values when discussing the performance of your DV1 viscometer with Brookfield technical support staff.

II.8.10 Service

The **Service Menu** is utilized by Brookfield and Brookfield Servicing Dealers. There is no customer use within the Service Menu.

II.9 Printing

The DV1 Viscometer is configured to print to the DYMO Label Writer 450 Turbo label printer. This printer can be purchased from Brookfield (Part No. GV-1046). No other printer is supported. The DV1 offers one printing format which is compatible with the Shipping Label (GV-1049-10, 2.31 inch x 4.00 inch) and the Address Label (GV-1048-10, 1.13 inch x 3.50 inch). When the larger label is used, the print out will still be formatted for the small label.

Printing will always be in English, regardless of the language chosen in the Options menu (see Section II.6).

Communication with the printer is established when the USB cable (provided with the printer) is connected between the printer and the DV1 Viscometer and both items are powered on. Printing will be available at the conclusion of a test through the use of the PRINT Hot Key (see Figure II.9).

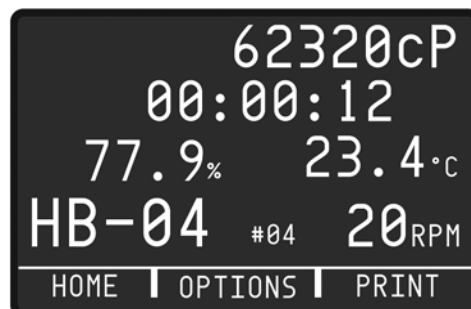

Figure II-9

An example printout is shown below. The data includes (from top left to bottom right):

00:00:12	RUN UNTIL	MANUAL
HB-04 #04	HB	20RPM
51920cP	23.2°C	64.9%

- **Actual Time of Test**
- **Test Mode (Run Until)**
- **Test Mode Parameter (Manual indicates no time given)**
- **Spindle represented by both name and number**
- **Torque range of the DV1 (HB)**
- **Speed**
- **Measured Viscosity**
- **Measured Temperature**
- **Measured Torque**

Communication to the printer can be reset by using the Connect function in the Options menu (see Section II.8.7).

III. MAKING VISCOSITY MEASUREMENTS

III.1 Quick Start

The DV1 Viscometer uses the same methodology for viscosity measurements as the Brookfield Dial Reading Viscometer and the DV series of Digital Viscometers. If you have experience with other Brookfield equipment, this section will give you the quick steps for taking a viscosity reading. If you have not used a Brookfield Viscometer before, skip this section and go to Section III.2 for a detailed description.

- A) Assemble the Laboratory Stand. Mount and level the DV1 Viscometer (Section I.5).
- B) Autozero the viscometer (Section II.2).
- C) Enter the spindle number and speed of rotation using the SPINDLE and SPEED Hot Keys functions (Sections II.5 and II.6).
- D) Select the End Condition type and parameter using the OPTIONS Hot Key function (Section II.8.1).
- E) Select the Test View parameter and mode using the OPTIONS Hot Key function (Section II.8.2).
- F) Introduce the spindle into the sample and attach the spindle to the coupling nut. **NOTE:** Left-handed threads.
- G) Press the Motor On key to initiate test.
- H) Record the test results.
- I) Press the Motor On key to repeat the test. Press the HOME Hot Key to return to the Home Screen.

III.2 Preparations for Making Measurements

- A) **VISCOMETER:** The DV1 should be turned on, leveled and autozeroed. The level is adjusted using the two feet on the bottom of the base and confirmed using the bubble on the top of the head. Adjust the feet until bubble is inside the center target. Set the level prior to performing the autozero and check the level prior to each measurement.

Proper level is essential for correct operation of the DV1.

- B) **SAMPLE:** The fluid to be measured (sample) must be in a container. The standard spindles, supplied with the DV1 (LV (1-4), RV (2-7), or HA/HB (2-7)), are designed to be used with a 600 mL low form Griffin beaker (or equivalent container with a diameter of 8.25cm). The same applies to the optional RV1, HA/HB1 spindle. Many other spindle systems are supplied from Brookfield with specific sample chambers such as the Small Sample Adapter, UL Adapter and Thermosel.

Brookfield recommends that you use the appropriate container for the selected spindle. You may choose to use an alternate container for convenience; however, this may have an effect on the measured viscosity. The DV1 is calibrated considering the specified container. Alternate containers will provide results that are repeatable but may not be “true.”

The LV (1-4) and RV (1-7) spindles are designed to be used with the guardleg attached. Measurements made without the guardleg will provide repeatable results but may not provide “true” results.

When comparing data with others, be sure to specify the sample container and presence/absence of the guardleg.

Many samples must be controlled to a specific temperature for viscosity measurement. When conditioning a sample for temperature, be sure to temperature control the container and spindle as well as the sample.

Please see our publication, “More Solutions to Sticky Problems”, for more details relating to sample preparation.

III.3 Selecting a Spindle/Speed

The DV1 has the capability of measuring viscosity over a wide range (for example, the DV1MRV can measure fluids within the range of 100-13,000,000 cP) (see Appendix B). This range is achieved through the use of several spindles over many speeds.

The process of selecting a spindle and speed for an unknown fluid is normally trial and error. **An appropriate selection will result in measurements between 10-100 on the instrument % torque scale.** Two general rules will help in the trial and error process.

1. Viscosity range is inversely proportional to the size of the spindle.
2. Viscosity range is inversely proportional to the rotational speed.

In other words: to measure high viscosity, choose a small spindle and/or a slow speed. If the chosen spindle/speed results in a reading above 100%, then reduce the speed or choose a smaller spindle.

Experimentation may reveal that several spindle/speed combinations will produce satisfactory results between 10-100%. When this circumstance occurs, any of the spindles may be selected.

Non-Newtonian fluid behavior can result in the measured viscosity changing if the spindle and/or speed is changed. See our publication, “More Solutions to Sticky Problems,” for more detail.

When viscosity data must be compared, be sure to use the same test methodology: the same instrument, spindle, speed, container, temperature and test time.

III.4 Running a Test

A viscosity test is started by pressing the Motor On key while viewing the Home Screen (Section II.2). Live measurement data will be displayed during the test. When the end criteria is met, the final data will be displayed on the DV1 until the user presses a key. The following procedure outlines the general steps necessary for making a viscosity measurement in a 600mL low form Griffin beaker using the standard LV/RV/HA/HB spindles (61-64, 2-7).

1. Level the DV1 Viscometer, remove any attached spindles, and perform Autozero.
2. Prepare the sample to be tested and transfer to the 600mL low form Griffin beaker.

3. Attach the guard leg (LV and RV series). Attach the spindle to the lower shaft. Lift the shaft slightly, holding it firmly with one hand while screwing the spindle on with the other (NOTE: Left-handed threads). Avoid putting side thrust on the shaft.
4. Enter the spindle number into the DV1 Viscometer by using the SPINDLE Hot Key. Enter the speed of rotation by using the SPEED Hot Key.
5. Insert and center the spindle in the test material. The spindle should be inserted to the immersion groove located on the spindle shaft. Use the Laboratory Stand Clamp to adjust the height of the Viscometer. With a disc-type spindle, it is sometimes necessary to tilt the spindle slightly while immersing to avoid trapping air bubbles under the surface of the disc. **You may find it more convenient to immerse the spindle in this fashion before attaching it to the viscometer.**
6. Select an end condition for the test using the RUN UNTIL function. This function is accessed through the RUN UNTIL feature found in the Options menu. Select an end condition (time, torque, temperature, or manual mode) and specify the parameter.
7. Select the appropriate display configuration using the TEST VIEW function. This function is accessed through the TEST VIEW feature found in the Options menu. Select a view and specify the format (static or variable). This feature allows the DV1 Viscometer to maximize the display size of the key parameter.
8. To make a viscosity measurement, press the Motor On key. If using the Manual End Condition, allow time for the indicated reading to stabilize. The time required for stabilization will depend on the speed at which the Viscometer is running and the characteristics of the sample fluid. Additional information on making viscosity measurements is available in Appendix C or the Brookfield publication “More Solutions to Sticky Problems”.
9. When the end condition is reached, the motor will stop and the measurement result will be displayed. If using the Manual End Condition, the test can be stopped by pressing the Motor Off key. Record the reading and relevant test parameters. Brookfield recommends you record at a minimum both % Torque and viscosity. Relevant test parameters might include: viscometer model, spindle, speed, temperature, container size and time of test. A label printer can be used with the DV1. See the sample Viscosity Test Report at the end of the Appendices.
10. If your test procedure calls for data collected at more than one speed, change the speed of rotation and repeat steps 8 and 9.
11. Remove the spindle and guard leg before cleaning. Remember to secure the viscometer shaft and lift up slightly while removing the spindle. Clean the spindles and guard leg after each use. See Section 1.8 for general cleaning recommendations.
12. Interpretation of results and the instrument's use with non-Newtonian and thixotropic materials is discussed in the publication, “More Solutions to Sticky Problems”, and in Appendix C: Variables in Viscosity Measurements.

III.5 Communication with Wingather SQ Soft-

The DV1 Viscometer can be used in conjunction with the Brookfield software program Wingather SQ. Wingather SQ will collect the data output from the DV1 and allow for: data storage, data printing, graphing, and mathematical analysis.

NOTE: Wingather SQ must be version 4.0 or higher for use with the DV1.

The DV1 Viscometer communicates to the PC through the USB A port (See Figure I-2). The communication cable will be supplied with the Wingather SQ software. Communication can be established once both the Wingather SQ software and the DV1 Viscometer are running. Use the Search or Connect button on the Wingather SQ dashboard (see Figure III-1). Successful communication will be indicated by a green light beside the Port designation.

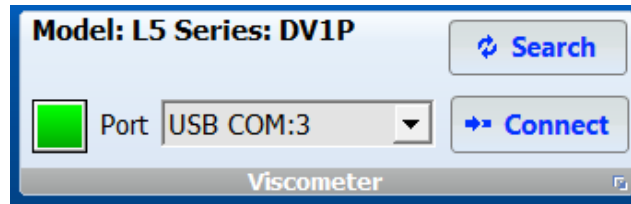

Figure III-1

TIP: If communication cannot be established between the DV1 and Wingather SQ, select the CONNECT function within the DV1 Options menu (see Section II.8.7).

Important features and benefits in Wingather SQ, which enhance operator versatility in performing a viscosity test, include:

- **Multiple Test Modes to enhance data collection**
- **Follow up events including analysis through math models**
- **Automatic sample numbering**
- **Data Export to Excel and pdf**
- **Import both test format and data files from earlier versions of Wingather**
- **Data Graphing of up to 20 data sets concurrently**

The following figures show the principal sections of Wingather SQ.



Figure III-2: Dashboard

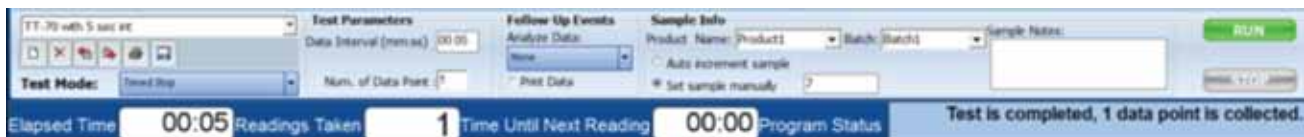

Figure III-3: Test Configuration

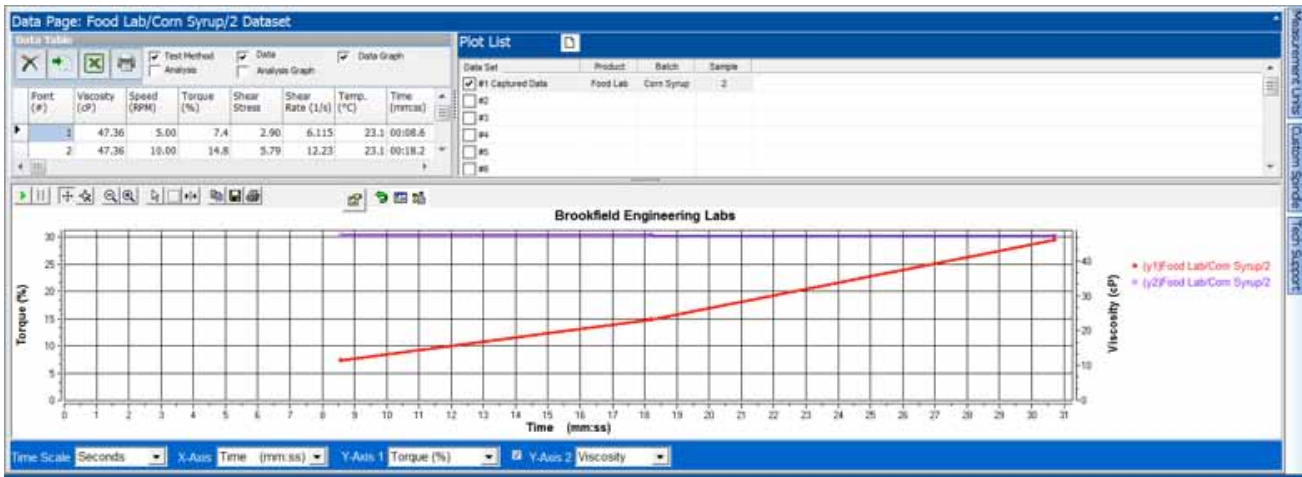

Figure III-4: Data Table and Graph

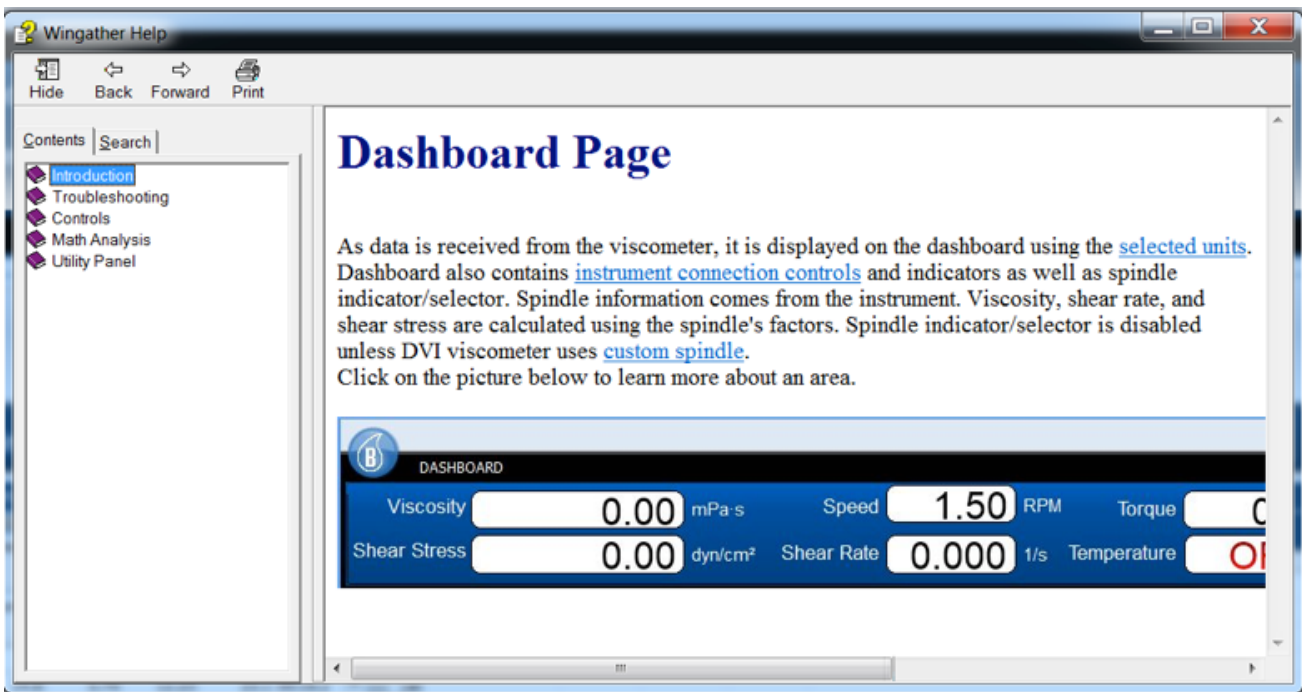

Figure III-5: Help Menu

Appendix A - Cone/Plate Viscometer Set-Up

This Cone/Plate version of the DV1 uses the same operating instruction procedures as described in this manual. However, the “gap” between the cone and the plate must be verified/adjusted before measurements are made. This is done by moving the plate (built into the sample cup) up towards the cone until the pin in the center of the cone touches the surface of the plate, and then by separating (lowering) the plate 0.0005 inch (0.013mm).

When operating the Cone/Plate at elevated temperature, the gap must be set with the cup and spindle equilibrated at the temperature recommended. Maximum temperature for Cone/Plate operation is 80°C. Maximum operational temperature of sample cup is 100°C. Personal protection is recommended when controlling to temperatures above 80°C.



Note: Micrometer Adjustment Ring will become hot when controlling sample cup at temperatures above 50°C.

DV1 Cone/Plate Viscometers have an Electronic Gap Setting feature. This feature enables the user to easily find the 0.0005 inch gap setting that was established at Brookfield prior to shipment.

Brookfield recommends that the maximum particle size in the sample material for measurement with cone/plate geometry be less than 5 times the gap setting. A more conservative approach is to limit the maximum particle size to less than 10 times the gap setting.

The following information explains how to set the Electronic Gap and verify calibration of the DV1 Viscometer.

A.1 Electronic Gap Setting Features

TOGGLE SWITCH allows you to enable/disable the Electronic Gap Setting Feature: left position is OFF (disabled), right position is ON (enabled).

PILOT LIGHT is the red (LED) light; when illuminated, it means the Electronic Setting Function is sensing (enabled).



Note: Be sure the light is off before introducing the test sample.

CONTACT LIGHT is the yellow (LED) light; when it first turns on, the “hit point” has been found.

SLIDING REFERENCE MARKER is used after finding the “hit point;” it is the reference for establishing the 0.0005 inch gap.

MICROMETER ADJUSTMENT RING is used to move the cup up or down in relation to the cone spindle. Turning the ring left (clockwise) lowers the cup; turning it right (counterclockwise) raises the cup. Each line on the ring represents one scale division and is equivalent to 0.0005 inch movement of the plate relative to the cone.

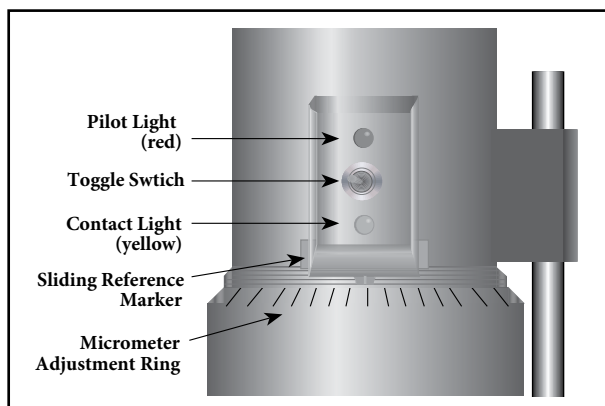

Figure A-1

A.2 Setup

1. Be sure that the Viscometer is securely mounted to the Laboratory Stand, leveled and zeroed with no cone or cup attached and 0% torque is displayed.
2. **Figure A-2** shows a typical water bath setup. Connect the sample cup inlet/outlet ports to the water bath inlet and outlet and set the bath to the desired test temperature. Allow sufficient time for the bath to reach the test temperature. The temperature range of the Sample Cup (CPE-44Y or CPE-44PY) is 0°-100°C. Brookfield recommends a maximum temperature of 80°C to allow for direct hand contact for adjustment of the micrometer ring. When using the sample cup at temperatures near 0°C, be careful to avoid frost buildup on the top surface of the cup; this could prevent a proper fit with the micrometer ring. Please refer to the bath manual for the proper selection of bath fluid and tubing to ensure safe and proper operation.
3. The Viscometer has been supplied with a special cone spindle(s), which contains the Electronic Gap Setting feature. The “CPE” part number designation on the cone verifies the Electronic Gap Setting feature.
4. With the motor off, thread the cone spindle by using the spindle wrench to secure the viscometer coupling nut (see **Figure A-3**); gently push up on the coupling nut and hold this securely with the wrench. Thread the cone spindle by hand. Note: Left Hand Threads.
5. Attach the cup, taking care not to hit the cone with the cup (**Figure A-4**). There must be no fluid in the cup.
6. Option: The sample cup is available with an optional purge fitting. The user can connect a dry gas line to this and put a blanket of dry gas over the sample during measurement, if desired.

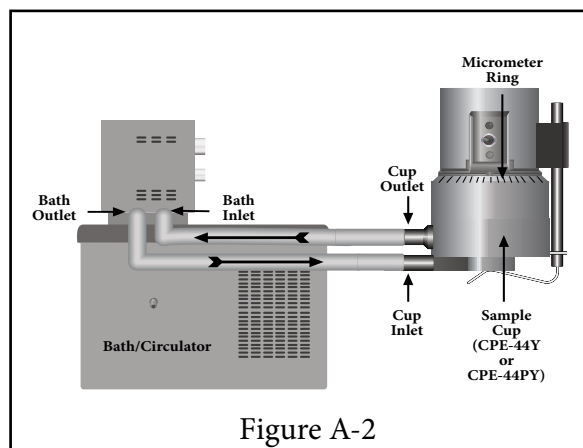

Figure A-2

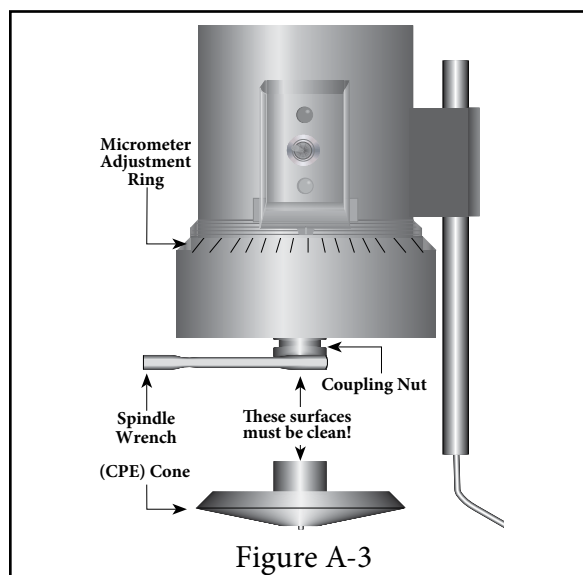

Figure A-3

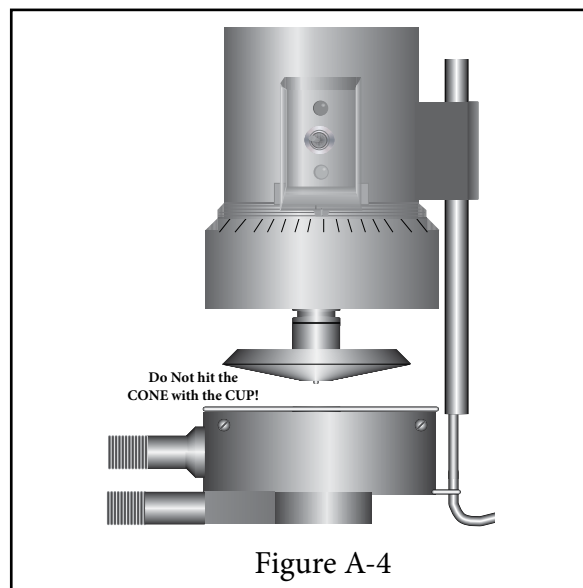

Figure A-4

A.3 Setting the Gap

1. Move the toggle switch to the right; this will turn on (enable) the Gap Setting Feature. The Pilot (red) light will be illuminated.
2. If the contact light (yellow) is illuminated, turn the micrometer adjustment ring clockwise (as you look down on the instrument) until the light is just breaking contact, i.e., flickering (see **Figure A-5**).
3. If the yellow contact light is not illuminated, *slowly* turn the micrometer adjustment ring in small increments (one or two scale divisions) counter-clockwise.

Continue moving the micrometer adjustment counter-clockwise until the contact light (yellow) turns on. Back off (rotate clockwise) until the light is just breaking contact, i.e., flickering.

4. Adjust the sliding reference marker, right or left, to the closest full scale division mark (see **Figure A-6**).
5. Turn the micrometer adjustment ring one scale division to the left to meet the line on the sliding reference marker. **THE YELLOW CONTACT LIGHT SHOULD GO OFF.**
6. You have established the gap space needed for measurement. **NOW TURN THE TOGGLE SWITCH OFF (LEFT); THE RED PILOT LIGHT SHOULD GO OFF.**

This viscosity of “electrically conductive” fluids may be affected if readings are taken with the Electronic Gap Setting feature “on”. Be sure to shut the feature “off” before taken readings!

7. Carefully remove the sample cup.

Notes:

1. The cup may be removed and replaced without resetting the gap, if the micrometer adjustment ring has not been moved.
2. Remove the spindle from the viscometer when cleaning.
3. Re-establish the hit point every time the spindle is attached/detached.

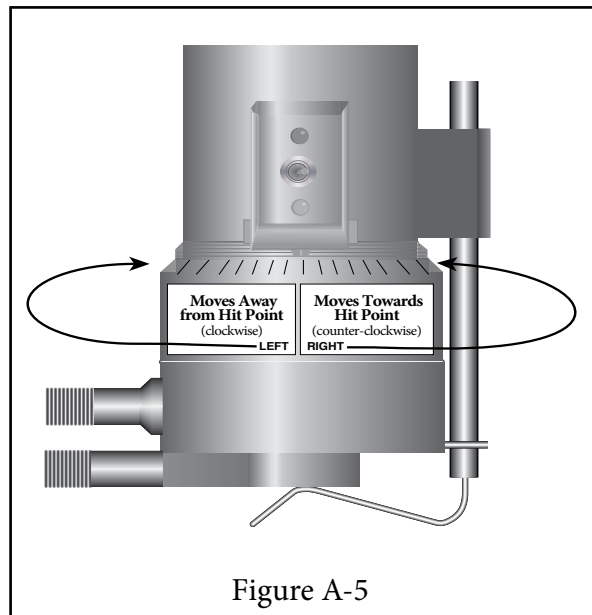

Figure A-5

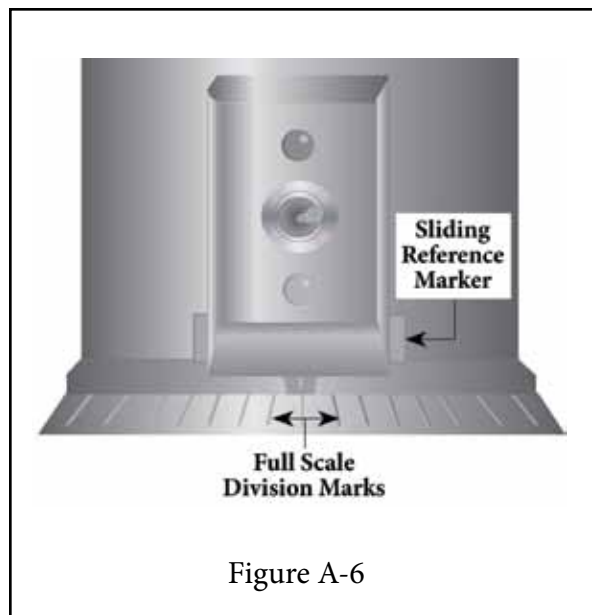

Figure A-6

A.4 Making Measurements with Cone/Plate Geometry

Viscosity measurements are made on the DV1 C/P viscometer in the same way as the DV1 viscometer with several exceptions.

1. Prepare the viscometer as is described in Section III.2.
2. Brookfield recommends that you always make cone/plate measurements with temperature control. Be sure that the sample cup is connected to a circulating waterbath and that it is at the target temperature. If the set temperature is far from ambient, you may wish to preheat the spindle as well as the cup. The spindle can be preheated by removing it from the viscometer and resting it in the cup (be careful not to scratch the measurement surfaces on the spindle or cup). Attach the spindle to the viscometer prior to the next step.
3. Set the Gap (see Appendix A; Section A.3) Brookfield recommends that the gap be set at the same temperature at which the measurement will be made.
4. Remove the sample cup.
5. Measure the precise volume of sample required for the spindle. See Table A-1. Sample volume can have a great affect on the measurement. In general, it is better to over fill the gap slightly than it is to under fill. It is also beneficial to establish a method of sampling that is repeatable to contribute to the repeatability of your viscosity measurement.
6. Insert the sample into the center of the sample cup. Avoid air bubbles when possible.
7. Attach the sample cup to the viscometer (be careful not to tilt the sample cup as this would reposition the sample from the center).
8. Wait for thermal equilibrium. Brookfield recommends a minimum of 1 minute for thermal equilibrium. You may want to increase this time if; there is a large difference in temperature between the sample and the control point, or if you have not preheated the spindle.
9. Operate the viscometer (see Section II.8, Steps 3 – 6). Refer to Section III.3 for assistance in selecting a spindle or speed.
10. Remove the sample cup at the conclusion of the test. Be careful to lower the cup so that no contact is made between the cup and spindle.
11. Remove the spindles (Refer to Appendix A; Section A.2, Step 4).

Cleaning: Refer to Section I.8 for general cleaning recommendations. Clean the cup and spindle at the conclusion of each test. Be careful not to let the sample dry or harden onto the spindle or cup since mechanical scraping may damage the measurement surfaces. Brookfield recommends that you remove the spindle prior to cleaning.

Take care not to scratch the measurement surface of the cup or spindle during the cleaning process. Take care not to drop the spindle; any dent on the outer edge of the spindle will affect the measurement.

The sample cup may be provided with an embedded temperature probe. The temperature probe connection should not be exposed to the cleaning solution or the test sample. Do not immerse the sample cup in a cleaning solution.

A.5 Verifying Calibration

1. Determine the appropriate sample volume. Refer to Table A-1 to determine the correct sample volume required for the spindle to be utilized.
2. Select a Brookfield Viscosity Standard fluid that will give viscosity readings between 10% and 100% of Full Scale Range. Refer to Appendix B for viscosity ranges of cone spindles; ranges listed apply to CPA cones.

Do not use a silicone viscosity standard fluid with a viscosity value greater than 5000 cP with a Cone/Plate. Brookfield offers a complete range of mineral oil viscosity standards suitable for use with Cone/Plates for viscosities above 5,000 cP or shear rates above 500 sec⁻¹; see Table F-1 and F-2 in Appendix F for a list of available fluids.

It is best to use a viscosity standard fluid that will be close to the maximum viscosity for a given cone spindle/speed combination.

Example: DV1MLV Viscometer, Cone Spindle CPA-42Z, Brookfield Silicone Viscosity Standard having a viscosity of 9.7 cP at 25°C.

At 60 RPM, the Full Scale Viscosity Range is 10.0 cP. Thus, the viscometer reading should be 97% torque and 9.7 cP viscosity ± 0.197 (closer to ± 0.2) cP. The accuracy is a combination of viscometer and fluid tolerance (refer to **Interpretation of Calibration Test Results** at the end of Appendix E).

3. With the motor off, remove the sample cup and place the viscosity standard fluid into the cup.

Cone Part No.	Sample Volume
CPA-40Z, CPE-40, CP-40	0.5 mL
CPA-41Z, CPE-41, CP-41	2.0 mL
CPA-42Z, CPE-42, CP-42	1.0 mL
CPA-51Z, CPE-51, CP-51	0.5 mL
CPA-52Z, CPE-52, CP-52	0.5 mL

Table A-1

4. Attach the sample cup to the viscometer and allow sufficient time for the sample, cup and cone to reach temperature equilibrium.
5. Turn the motor on. Set the desired speed(s). Measure the viscosity and record the reading in both % torque and centipoise (cP).

NOTE: The cone spindle must rotate at least five (5) times before a viscosity reading is taken.

6. Verify that the viscosity reading is within the allowable 1% deviation, as explained earlier, for the specific viscosity standard fluid(s) that you are using.

* The CPA or CPE designation on the cone spindle indicates use with Electronic Gap Setting Cone/Plate Viscometers/Rheometers **only**.

Appendix B - Viscosity Ranges

LV (#1-4) and RV,HA,HB (#1-7) Viscometers

Viscosity Range (cP)		
Viscometer	Minimum	Maximum
DV1MLV	15	2,000,000
DV1MRV	100*	13,300,000
DV1MHA	200*	26,600,000
DV1MHB	800*	106,400,000

**Minimum viscosity is achieved with optional RV/HA/HB-1 spindle. (Spindle Code 01)*

Vane Spindles

Spindle	Torque Range	Shear Stress Range		Viscosity Range cP (mPa•s) @ 10 RPM	
		Pa	dyne/cm ²		
V-71	LV	NOT RECOMMENDED FOR USE ON LV TORQUE			
V-72	LV	.188-1.88	1.88-18.8	199 -	1990
V-73	LV	.938-9.38	9.38-93.8	996 -	9960
V-74	LV	9.38-93.8	93.8-938	4990 -	49900
V-75	LV	3.75-37.5	37.5-375	1996 -	19960
V-71	RV	.5-5	5-50	262 -	2620
V-72	RV	2-20	20-200	1110 -	11100
V-73	RV	10-100	100-1000	5350 -	53500
V-74	RV	100-1000	1000-10000	54300 -	543000
V-75	RV	40-400	400-4000	21300 -	213000
V-71	HA	1-10	10-100	524 -	5240
V-72	HA	4-40	40-400	2220 -	22200
V-73	HA	20-200	200-2000	10700 -	107000
V-74	HA	200-2000	2000-20000	108600 -	1086000
V-75	HA	80-800	800-8000	42600 -	426000
V-71	HB	4-40	40-400	2096 -	20960
V-72	HB	16-160	160-1600	8880 -	88800
V-73	HB	80-800	800-8000	42800 -	428000
V-74	HB	800-8000	8000-80000	434400 -	4344000
V-75	HB	320-3200	3200-32000	170400 -	1704000

Notes: 1) 1 Pa = 10 dyne/cm²

2) 1 cP = 1 mPa•s

3) Possibility of turbulence at speeds above 10 RPM may give artificially higher viscosity readings.

Small Sample Adapter and Thermosel

SSA and Thermosel Spindle	Viscosity Range (cP)		Shear Rate sec ⁻¹
	DV1MLV		
SC4-16	120	- 400,000	.29N
SV4-18	3	- 10,000	1.32N
SC4-25	480	- 1,600,000	.22N
SC4-31	30	- 100,000	.34N
SC4-34	60	- 200,000	.28N
SC4-81	3	- 10,000	1.29N
SC4-82	3	- 10,000	1.29N
SC4-83	11	- 38,000	1.29N

SSA and Thermosel Spindle	Viscosity (cP)			Shear Rate sec ⁻¹
	DV1MRV	DV1MHA	DV1MHB	
SC4-14	1,250 - 4,165,000	2,500 - 8,330,000	10,000 - 33,360,000	.40N
SC4-15	500 - 1,660,000	1,000 - 3,320,000	4,000 - 13,280,000	.48N
SC4-25	0 - 167,000	100 - 334,000	400 - 1,336,000	.93N
SC4-27	250 - 830,000	500 - 1,660,000	2,000 - 6,640,000	.34N
SC4-28	500 - 1,660,000	1,000 - 3,320,000	4,000 - 3,280,000	.28N
SC4-29	1,000 - 3,330,000	2,000 - 6,660,000	8,000 - 26,640,000	.25N
Thermosel SC4-81	37 - 10,000	73.0 - 10,000	292 - 10,000	1.29N
SSA SC4-82	37 - 10,000	73.0 - 10,000	292 - 10,000	1.29N
SSA SC4-83	121 - 50,000	243 - 50,000	970 - 50,000	1.29N

UL Adapter

UL Spindle	Viscosity (cP)				Shear Rate sec ⁻¹
	DV1MLV	DV1MRV	DV1MHA	DV1MHB	
YULA-15 or 15Z	1 - 2,000	7 - 2,000	13 - 2,000	52 - 2,000	1.22N
ULA-DIN-Y	1 - 3,800	11 - 5,000	22 - 5,000	85 - 2000	1.29N

DIN Adapter Accessory

DAA Spindle	Viscosity (cP)				Shear Rate sec-1
	DV1MLV	DV1MRV	DV1MHA	DV1MHB	
85	2 - 4,000	12 - 5,000	24 - 5,000	98 - 5,000	1.29N
86	4 - 3,800	37 - 10,000	73 - 10,000	292 - 10,000	1.29N
87	11 - 38,000	121 - 50,000	243 - 50,000	970 - 50,000	1.29N

Spiral Adapter

Spiral Spindle	Viscosity (cP)				Shear Rate sec-1
	DV1MLV	DV1MRV	DV1MHA	DV1MHB	
SA-70	98 - 98,500	1,000 - 1,050,000	2,100 - 2,100,000	8,400 - 8,400,000	.00677 - .67.7N (1-100 RPM)

Cone/Plate Viscometer

Cone Spindle	Viscosity (cP)				Shear Rate sec-1
	DV1MLV	DV1MRV	DV1MHA	DV1MHB	
CPE-40	.30 - 1,028	3 - 10,900	7 - 21,800	26 - 87,200	7.5N
CPE-41	1.15 - 3,840	12 - 41,000	25 - 82,000	98 - 328,000	2.0N
CPE-42	.60 - 2,000	6 - 21,300	13 - 42,600	51 - 170,400	3.84N
CPE-51	4.8 - 16,178	51.8 - 172,600	103.4 - 345,200	414.2 - 1,380,800	3.84N
CPE-52	9.3 - 31,000	99.2 - 330,733	198.4 - 661,466	793.6 - 2,645,866	2.0N

Helipath with T-Bar Spindles

T-Bar Spindle	Viscosity (cP)			
	DV1MLV	DV1MRV	DV1MHA	DV1MHB
T-A	156 - 62,400	2,000 - 400,000	4,000 - 800,000	16,000 - 3,200,000
T-B	312 - 124,800	4,000 - 800,000	8,000 - 1,600,000	32,000 - 6,400,000
T-C	780 - 312,000	10,000 - 2,000,000	20,000 - 4,000,000	80,000 - 16,000,000
T-D	1,560 - 624,000	20,000 - 4,000,000	40,000 - 8,000,000	160,000 - 32,000,000
T-E	3,900 - 1,560,000	50,000 - 10,000,000	100,000 - 20,000,000	400,000 - 80,000,000
T-F	7,800 - 3,120,000	100,000 - 20,000,000	200,000 - 40,000,000	800,000 - 160,000,000

When taking viscosity measurements with the DV1 Viscometer, there are two considerations, which pertain to the low viscosity limit of effective measurement.

1. Viscosity measurements should be taken within the equivalent % Torque Range from 10% to 100% for any combination of spindle/speed rotation.
2. Viscosity measurements should be taken under laminar flow conditions, not under turbulent flow conditions.

The first consideration has to do with the accuracy of the instrument. All DV1 Viscometers have a Full Scale Range allowable error of (+/-) 1% of any spindle/speed in use. We discourage taking readings below 10% of range because the potential viscosity error of (+/-) 1% is a relatively high number compared to the instrument reading.

The second consideration involves the mechanics of fluid flow. All rheological measurements of fluid flow properties should be made under laminar flow conditions. Laminar flow is flow wherein all particle movement is in layers directed by the shearing force. For rotational systems, this means all fluid movement must be circumferential. When the inertial forces on the fluid become too great, the fluid can break into turbulent flow wherein the movement of fluid particles becomes random and the flow cannot be analyzed with standard math models. This turbulence creates a falsely high viscometer reading with the degree of non-linear increase in reading being directly related to the degree of turbulence in the fluid.

For the following geometries, we have found that an approximate transition to the onset of turbulent flow occurs in the following situation:

- 1) No. 1 LV Spindle: 15 **cP** at 60 RPM
- 2) No 2 LV Spindle: 100 **cP** at 200 RPM
- 3) No. 1 RV Spindle: 100 **cP** at 50 RPM (optional spindle available from Brookfield)
- 4) UL Adapter: 0.85 **cP** at 60 RPM

Turbulent conditions may exist in these situations whenever the RPM/cP ratio exceeds the values listed above. The viscosity at which turbulence starts is still at best a guess because it is a relationship between viscous and inertial forces, and it can vary dramatically from fluid to fluid. Turbulence starts as a small deviation or increase in viscosity for a Newtonian fluid and grows quickly. Basically, there is no specific shear that it starts at, only an approximate region of shear depending on the fluid.

Appendix C - Variables in Viscosity Measurement

As with any instrument measurement, there are variables that can affect a viscometer measurement. These variables may be related to the instrument (viscometer), or the test fluid. Variables related to the test fluid deal with the rheological properties of the fluid, while instrument variables would include the viscometer design and the spindle geometry system utilized.

Rheological Properties

Fluids have different rheological characteristics that can be described by viscometer measurements. We can then work with these fluids to suit the lab or process conditions.

There are two categories of fluids:

Newtonian

- These fluids have the same viscosity at different Shear Rates (different RPM's) and are called Newtonian over the Shear Rate range they are measured.

Non-Newtonian

- These fluids have different viscosities at different shear rates (different RPM's). They fall into two groups:

- 1) Time Independent
- 2) Time Dependent

Time Independent means that the viscosity behavior does not change as a function of time when measuring at a specific shear rate.

Pseudoplastic

- A pseudoplastic material displays a decrease in viscosity with an increase in shear rate, and is also known as “shear thinning”. If you take viscometer readings from a low to a high RPM and then back to the low RPM, and the readings fall upon themselves, the material is time independent, pseudoplastic and shear thinning.

Time Dependent means that the viscosity behavior changes as a function of time when measuring at a specific shear rate.

Thixotropic

- A thixotropic material has decreasing viscosity under constant shear rate. If you set a viscometer at a constant speed recording viscosity values over time and find that the viscosity values decrease with time, the material is thixotropic.

Brookfield publication, “*More Solutions to Sticky Problems*”, includes a more detailed discussion of rheological properties and non-Newtonian behavior.

Viscometer Related Variables

Most fluid viscosities are found to be non-Newtonian. They are dependent on Shear Rate and the spindle geometry conditions. The specifications of the viscometer spindle and chamber geometry will affect the viscosity readings. If one reading is taken at 2.5 rpm, and a second at 50 rpm, the two viscosity values produced will be different because the readings were made at different shear rates. The faster the spindle speed, the higher the shear rate.

The shear rate of a given measurement is determined by: the rotational speed of the spindle, the size and shape of the spindle, the size and shape of the container used and therefore, the distance between the container wall and the spindle surface.

A repeatable viscosity test should control or specify the following:

- 1) Test temperature
- 2) Sample container size (or spindle/chamber geometry)
- 3) Sample volume
- 4) Viscometer model
- 5) Spindle used numbered
- 6) Test speed or speeds (or the shear rate)
- 7) Length of time or number of spindle revolutions to record viscosity
- 8) Presence/absence of guard leg (LV or RV models)

Appendix D - Spindle Entry Codes and SMC/SRC Values

When using a standard Brookfield digital Viscometer or Rheometer, each spindle has a two digit entry code which is entered via the keypad on the DV1. The entry code allows the DV1 to calculate Viscosity, Shear Rate and Shear Stress values and can also be calculated when using coaxial cylinder geometry (SSA, ULA, Thermosel, DAA, etc.) and cone/plate geometry.

Each spindle has two constants which are used in these calculations. The Spindle Multiplier Constant (SMC) used for viscosity and shear stress calculations, and the Shear Rate Constant (SRC), used for shear rate and shear stress calculations. Note that where SRC = 0, no shear rate/shear stress calculations are done and the data displayed is zero (0) for these functions.

Table D-1
(Continued on following page)

SPINDLE	ENTRY CODE	SMC	SRC
RV1	01	1	0
RV2	02	4	0
RV3	03	10	0
RV4	04	20	0
RV5	05	40	0
RV6	06	100	0
RV7	07	400	0
HA1	01	1	0
HA2	02	4	0
HA3	03	10	0
HA4	04	20	0
HA5	05	40	0
HA6	06	100	0
HA7	07	400	0
HB1	01	1	0
HB2	02	4	0
HB3	03	10	0
HB4	04	20	0
HB5	05	40	0
HB6	06	100	0
HB7	07	400	0
LV1	61	6.4	0
LV2	62	32	0
LV3	63	128	0
LV4 or 4B2	64	640	0
LV5	65	1280	0
LV-2C	66	32	0.212
LV-3C	67	128	0.210
Spiral	70	105	0.677
T-A	91	20	0
T-B	92	40	0

SPINDLE	ENTRY CODE	SMC	SRC
T-C	93	100	0
T-D	94	200	0
T-E	95	500	0
T-F	96	1000	0
ULA	00	0.64	1.223
HT-DIN-81	81	3.7	1.29
SC4-DIN-82	82	3.75	1.29
SC4-DIN-83	83	12.09	1.29
DIN-85	85	1.22	1.29
DIN-86	86	3.65	1.29
DIN-87	87	12.13	1.29
SC4-14	14	125	0.4
SC4-15	15	50	0.48
SC4-16	16	128	0.29
SC4-18	18	3.2	1.32
SC4-21	21	5	0.93
SC4-25	25	512	0.22
SC4-27	27	25	0.34
SC4-28	28	50	0.28
SC4-29	29	100	0.25
SC4-31	31	32	0.34
SC4-34	34	64	0.28
CP-40 / CPE-40 / CPA-40Z	40	0.327	7.5
CP-41 / CPE-41 / CPA-41Z	41	1.228	2
CP-42 / CPE-42 / CPA-42Z	42	0.64	3.84
CP-51 / CPE-51 / CPA-51Z	51	5.178	3.84
CP-52 / CPE-52 / CPA-52Z	52	9.922	2
V-71	71	2.62	0
V-72	72	11.1	0
V-73	73	53.5	0
V-74	74	543	0
V-75	75	213	0

Table D-1
(Continued from previous page)

Table D-2 lists the model codes and spring torque constants for each viscometer model.

VISCOMETER MODEL	TORQUE CONSTANT TK	MODEL CODE ON DV1 SCREEN
DV1MLV	0.09373	LV
2.5xDV1MLV	0.2343	2.5LV
5xDV1MLV	0.4686	5LV
1/4 DV1MRV	0.25	1/4RV
1/2 DV1MRV	0.5	1/2RV
DV1MRV	1	RV
DV1MHA	2	HA
2xDV1MHA	4	2HA
2.5xDV1MHA	5	2.5HA
DV1MHB	8	HB
2xDV1MHB	16	2HB
2.5xDV1HB	20	2.5HB

Table D-2

The full scale viscosity range for any DV1 model and spindle may be calculated using the equation:

$$\text{Full Scale Viscosity Range [cP]} = \text{TK} * \text{SMC} * \frac{10,000}{\text{RPM}}$$

where:

TK = DV1 Torque Constant from Table D-2

SMC = Spindle Multiplier Constant from Table D-1

The Shear Rate calculation is:

$$\text{Shear Rate (} \frac{1}{\text{sec}} \text{)} = \text{SRC} * \text{RPM}$$

where:

SRC = Shear Rate Constant from Table D-1

Appendix E - Spindle Entry Codes and Range Coefficients

The range coefficient is a convenient tool for quickly determining the maximum viscosity that can be measured with a specific spindle/speed combination. Identify the spindle in use and the torque range (LV, RV, HA, HB) of the Viscometer/Rheometer. Look up the Range Coefficient in the following table. Divide the Range Coefficient by the spindle speed to determine the maximum viscosity in centipoise that can be measured.

E.g. RV Viscometer with RV3 spindle: Range Coefficient is 100,000. At 50 RPM, the maximum viscosity that can be measured is 100,000/50 or 2,000 cP.

The Entry Code is the two digit number used to identify the spindle in use when operating a standard digital Viscometer/Rheometer.

Table E-1
(Continued on following page)

Spindle	Entry Code	Range Coefficient			
		LV	RV	HA	HB
RV1	01	937	10,000	20,000	80,000
RV2	02	3,750	40,000	80,000	320,000
RV3	03	9,375	100,000	200,000	800,000
RV4	04	18,750	200,000	400,000	1,600,000
RV5	05	37,500	400,000	800,000	3,200,000
RV6	06	93,750	1,000,000	2,000,000	8,000,000
RV7	07	375,000	4,000,000	8,000,000	32,000,000
HA1	01	937	10,000	20,000	80,000
HA2	02	3,750	40,000	80,000	320,000
HA3	03	9,375	100,000	200,000	800,000
HA4	04	18,750	200,000	400,000	1,600,000
HA5	05	37,500	400,000	800,000	3,200,000
HA6	06	93,750	1,000,000	2,000,000	8,000,000
HA7	07	375,000	4,000,000	8,000,000	32,000,000
HB1	01	937	10,000	20,000	80,000
HB2	02	3,750	40,000	80,000	320,000
HB3	03	9,375	100,000	200,000	800,000
HB4	04	18,750	200,000	400,000	1,600,000
HB5	05	37,500	400,000	800,000	3,200,000
HB6	06	93,750	1,000,000	2,000,000	8,000,000
HB7	07	375,000	4,000,000	8,000,000	32,000,000
LV1	61	6,000	64,000	128,000	512,000
LV2	62	30,000	320,000	640,000	2,560,000
LV3	63	120,000	1,280,000	2,560,000	10,240,000
LV4 or 4B2	64	600,000	6,400,000	12,800,000	51,200,000
LV5	65	1,200,000	12,800,000	25,600,000	102,400,000
LV-2C	66	30,000	320,000	640,000	2,560,000

Spindle	Entry Code	Range Coefficient			
		LV	RV	HA	HB
LV-3C	67	120,000	1,280,000	2,560,000	10,240,000
T-A	91	18,750	200,000	400,000	1,600,000
T-B	92	37,440	400,000	800,000	3,200,000
T-C	93	9,3600	1,000,000	2,000,000	8,000,000
T-D	94	187,200	2,000,000	4,000,000	16,000,000
T-E	95	468,000	5,000,000	10,000,000	40,000,000
T-F	96	936,000	10,000,000	20,000,000	80,000,000
Spiral	70	98,400	1,050,000	2,100,000	8,400,000
ULA	00	600	6,400	12,800	51,200
HT-DIN-81	81	3,420	36,500	73,000	292,000
SC4-DIN-82	82	3,420	36,500	73,000	292,000
SC4-DIN-83	83	11,340	121,300	242,600	970,400
ULA-DIN-85	85	1,144	12,200	24,400	97,600
ULA-DIN-86	86	3,420	36,500	73,000	292,000
ULA-DIN-87	87	11,340	121,300	242,600	970,400
SC4-14/6R	14	117,200	1,250,000	2,500,000	10,000,000
SC4-15/7R	15	46,880	500,000	1,000,000	4,000,000
SC4-16/8R	16	120,000	1,280,000	2,560,000	10,240,000
SC4-18/13R	18	3,000	32,000	64,000	256,000
SC4-21/13R	21	4,688	50,000	100,000	400,000
SC4-25/13R	25	480,000	5,120,000	10,240,000	40,960,000
SC4-27/13R	27	23,440	250,000	500,000	2,000,000
SC4-28/13R	28	46,880	500,000	1,000,000	4,000,000
SC4-29/13R	29	93,750	1,000,000	2,000,000	8,000,000
SC4-31/13R	31	30,000	320,000	640,000	2,560,000
SC4-34/13R	34	60,000	640,000	1,280,000	5,120,000
CPA-40Z, CPE-40, CP-40	40	307	3,270	6,540	26,160
CPA-41Z, CPE-41, CP-41	41	1,151	12,280	24,560	98,240
CPA-42Z, CPE-42, CP-42	42	600	6,400	12,800	51,200
CPA-51Z, CPE-51, CP-51	51	4,854	51,780	103,560	414,240
CPA-52Z, CPE-52, CP-52	52	9,300	99,220	198,440	793,760
V-71	71	2,456	26,200	52,400	209,600
V-72	72	10,404	111,000	222,000	888,000
V-73	73	50,146	535,000	1,070,000	4,280,000
V-74	74	508,954	5,430,000	10,860,000	43,440,000
V-75	75	199,645	2,130,000	4,260,000	8,520,000

Table E-1
(Continued on previous page)

Appendix F - Calibration Check Procedures

For more help go to
www.brookfieldengineering.com and download the video.

Brookfield's accuracy statement for viscometers used with standard spindles is +/-1% of Full Scale Range. When measuring viscosity with a specific spindle rotating at a defined speed, the maximum viscosity that can be measured is defined as Full Scale Range. For digital viscometers this value is easily determined by pressing the "AUTORANGE" key. The display will show the Full Scale Range viscosity in cP or mPa•s and the torque value will show 100%. Multiply the Full Scale Range viscosity by 1% to determine the accuracy of any future measurement made with that spindle/speed combination.

When using the following accessory devices with your viscometer, the accuracy is +/-2%. Dimensional tolerances in the accessory device allow for increase from +/-1% to +/-2%.

- Small Sample Adapter
- Thermosel
- UL Adapter
- DIN Adapter
- Spiral Adapter

The accuracy of the DV1 is verified using viscosity standard fluids, which are available from Brookfield Engineering Laboratories or your local Brookfield agent. Viscosity standards are Newtonian, and therefore, have the same viscosity regardless of spindle speed (or shear rate). Viscosity standards, calibrated at 25°C, are shown in **Table F-1** (Silicone Oils) and **Table F-2** (Mineral Oils).

Container size: For Viscosity Standards < 30,000 cP, use a 600 mL Low Form Griffin Beaker having a working volume of 500 mL.

Inside Diameter: 3.25" (8.25cm)

Height: 4.75" (12.1cm)

For Viscosity Standards ≥ 30,000 cP, use the fluid container.

Note: Container may be larger, but may not be smaller.

Temperature: As stated on the fluid standard label: (+/-) 0.1°C

Conditions: The DV1 should be set according to the operating instructions. The water bath must be stabilized at test temperature. Viscometers with the letters "LV" or "RV" in the model designation must have the guard leg attached, see Appendix G for more information on the guard leg).

Normal 25°C Standard Fluids		High Temperature Standard Fluids
Viscosity (cP)	Viscosity (cP)	Three Viscosity/Temperatures**
5	5,000	HT-30,000
10	12,500	HT-60,000
50	30,000	HT-100,000
100	60,000	
500	100,000	**25°C, 93.3°C, 149°C
1,000		Refer to Brookfield catalog for more information

Table F-1

MINERAL OIL VISCOSITY STANDARD FLUIDS	
BEL Part No.	Viscosity (cP) 25°C
B29	29
B200	200
B600	600
B1060	1,060
B2000	2,000
B10200	10,200
B21000	21,000
B730000	73,000
B200000	200,000
B360000	360,000

Table F-2

Brookfield Viscosity Standard Fluid - General Information

We recommend that Brookfield Viscosity Standard Fluids be replaced on an annual basis, one year from date of initial use. These fluids are either pure silicone or mineral oil and are not subject to change over time. However, exposure to outside contaminants through normal use requires replacement on an annual basis. Contamination may occur by the introduction of solvent, standard of different viscosity or other foreign material.

Viscosity Standard Fluids may be stored under normal laboratory conditions. Mineral oils should be stored in the container in which they are supplied. Disposal should be in accordance with state, local and federal regulations as specified on the material safety data sheet; MSDS information is available upon request on our website to download.

Brookfield Engineering Laboratories does not recertify Viscosity Standard Fluids. We will issue duplicate copies of the Certificate of Calibration for any fluid within two years of the purchase date.

Brookfield Viscosity Standard Fluids are reusable provided they are not contaminated. Normal practice for usage in a 600 mL beaker is to return the material from the beaker back into the bottle. When using smaller volumes in accessories such as Small Sample Adapter, UL Adapter, Thermosel or Spiral Adapter, the fluid is normally discarded.

Calibration Check Procedure for LV (#1-3) and RV,HA,HB (#1-6) Brookfield Spindles

NOTE: The LV #4 (#64) and the RV, HA, HB #7 spindle have been omitted from this procedure. Brookfield does not recommend the use of these spindles to perform a calibration check on your instrument. Reasons pertain to the small amount of spindle surface area that makes contact with the viscosity standard, the difficulty of establishing the immersion mark precisely and the need for precise temperature control at 25°C in the immediate vicinity of the spindle.

Follow these steps using one of the recommended spindles to verify calibration of your instrument.

- 1) Place the viscosity standard fluid (in the proper container) into the water bath.
- 2) Lower the **DV1** into measurement position (with guard leg if **LV** or **RV** series viscometer is used).
- 3) Attach the spindle to the viscometer. If you are using a disk shaped spindle, avoid trapping air bubbles beneath the disk by first immersing the spindle at an angle, and then connecting it to the viscometer.
- 4) The viscosity standard fluid, together with the spindle and guardleg, should be immersed in the bath for a **minimum** of 1 hour, stirring the fluid periodically, prior to taking measurements.

 Don't introduce air bubbles.

The spindle can be rotated in the fluid to accelerate temperature equilibrium.

- 5) After 1 hour, check the temperature of the viscosity standard fluid with an accurate thermometer. Fluid must be within $\pm 0.1^\circ\text{C}$ of the specified temperature, normally 25°C . Allow longer soak time if required to come to test temperature.
- 6) If the fluid is at test temperature, measure the viscosity and record the viscometer reading; include % and cP (mPa•s).

NOTE: The spindle must rotate at least five (5) times before readings are taken.

- 7) The viscosity reading should equal the **cP** value on the viscosity fluid standard to within the combined accuracies of the viscometer and the standard (as discussed in the end of this section entitled, **Interpretation of Calibration Test Results**).

Calibration Check Procedure for a Small Sample Adapter

When a Small Sample Adapter is used, the water jacket is connected to the water bath and the water is stabilized at the proper temperature:

- 1) Put the proper amount of viscosity standard fluid into the sample chamber. The amount varies with each spindle/chamber combination. (Refer to the Small Sample Adapter instruction manual.)
- 2) Place the sample chamber into the water jacket.
- 3) Put the spindle into the test fluid and attach the extension link, coupling nut and free hanging spindle (or directly attach the solid shaft spindle) to the **DV1**.
- 4) Allow sufficient time for the viscosity standard, sample chamber and spindle to reach test temperature.
- 5) Measure the viscosity and record the viscometer reading; include % and cP (mPa•s).

NOTE: The spindle must rotate at least five (5) times before readings are taken.

Calibration Check Procedure for a Thermosel System

A two-step process is recommended for the Thermosel.

- 1) Evaluate the calibration of the Viscometer alone according to the procedure outlined in the beginning of this section, entitled **Calibration Procedure for LV (#1-3) and RV, HA, HB (#1-6) Brookfield spindles**.

- 2) Evaluate the Viscometer with the Thermosel according to the procedure described below.

When a Thermosel System is used, the controller stabilizes the Thermo Container at the test temperature. **DO NOT USE THE THERMOSEL TO CONTROL TO TEMPERATURES WITHIN 15° OF AMBIENT TEMPERATURES.** Consult your Thermosel manual for details.

- 3) Put the proper amount of HT viscosity standard fluid into the HT-2 sample chamber. The amount varies with the spindle used. (Refer to the Thermosel instruction manual).
- 4) Place the sample chamber into the Thermo Container.
- 5) Put the spindle into the test fluid and attach the extension link, coupling nut and free hanging spindle (or directly attach the solid shaft spindle) to the **DV1**.
- 6) Allow sufficient time for the viscosity standard, sample chamber and spindle to reach test temperature.
- 7) Measure the viscosity and record the viscometer reading; include % and cP (mPa•s).

NOTE: The spindle must rotate at least five (5) times before readings are taken.

Calibration Check Procedures for UL Adapter

When a UL Adapter is used, the water bath is stabilized at the proper temperature:

- 1) Put the proper amount of viscosity standard fluid into the UL closed Tube. (Refer to the UL Adapter instruction manual).
- 2) Attach the spindle (with coupling nut) onto the **DV1**.
- 3) Attach the tube to the mounting bracket.
- 4) Lower the tube into the water bath reservoir, or if using the ULA-40Y water jacket, connect the inlet/outlets to the bath external circulating pump.
- 5) Allow sufficient time for the viscosity standard, sample chamber and spindle to reach test temperature.
- 6) Measure the viscosity and record the viscometer reading; include % and cP (mPa•s).

NOTE: The spindle must rotate at least five (5) times before readings are taken.

Calibration Check Procedures for DIN Adapter

When a DIN UL Adapter is used, the water bath is stabilized at the proper temperature:

- 1) Put the proper amount of viscosity standard fluid into the UL Tube. (Refer to the UL Adapter instruction manual).
- 2) Attach the spindle (with extension link and coupling nut) onto the **DV1**.
- 3) Attach the tube to the mounting channel.
- 4) Lower the tube into the water bath reservoir, or if using the ULA-40Y water jacket, connect the inlet/outlets to the bath external circulating pump.
- 5) Allow sufficient time for the viscosity standard, sample chamber and spindle to reach test temperature.
- 6) Measure the viscosity and record the viscometer reading; include % and cP (mPa•s).

NOTE: The spindle must rotate at least five (5) times before readings are taken.

Calibration Check Procedure for a Helipath Stand and T-Bar Spindles

T-Bar spindles **should not** be used for verifying calibration of the **DV1** Viscometer.

When a Helipath Stand and T-Bar spindles are used:

Remove the T-bar spindle and select a standard LV (#1-3) or RV,HA,HB (#1-6) spindle. Follow the procedures in the beginning of this section, entitled **Calibration Procedure for LV (#1-3) and RV, HA, HB (#1-6) Brookfield spindles**.

Calibration Check Procedure for Spiral Adapter

- 1) Place the viscosity standard fluid (in the proper container) into the water bath.
- 2) Attach the spindle to the viscometer. Attach chamber (SA-1Y) and clamp to the viscometer.
- 3) Lower the DV1 into measurement position. Operate the viscometer at 50 or 60 RPM until the chamber is fully flooded.
- 4) The viscosity standard fluid, together with the spindle, should be immersed in the bath.

 Don't introduce air bubbles.

Stirring the fluid periodically (operate at 50 or 60 RPM), prior to taking measurements to encourage temperature equilibrium.

NOTE: The spindle must rotate at least five (5) times before readings are taken.

- 5) Measure viscosity and record the viscometer reading; include % and cP (mPa•s). Instrument accuracy is $\pm 2\%$ of the maximum viscosity range and not the standard 1%.

Calibration Check Procedure for Cone/Plate Viscometers

- 1) Follow the procedures outlined in **Appendix A** for mechanically adjusting the setting of the cone to the plate.
- 2) Refer to **Appendix A, Table A-1**, and determine the correct sample volume required for the spindle to be utilized.
- 3) Select a viscosity standard fluid that will give viscosity readings between 10% and 100% of Full Scale Range. Refer to **Appendix B** for viscosity ranges of cone spindles. Do not use a silicone viscosity standard fluid with a viscosity value greater than 5000 cP with a Cone/Plate Viscometer. Brookfield offers a complete range of mineral oil viscosity standards suitable for use with Cone/Plate Viscometers. **See Table F-2 in Appendix F**. It is best to use a viscosity standard fluid that will be close to the maximum viscosity for a given cone spindle/speed combination.

DV1MLV Viscometer, Cone CP-42, Fluid 10
Having a viscosity of 9.7 cP at 25°C

At 60 RPM, the Full Scale Viscosity Range is 10.0 cP. Thus, the Viscometer reading should be 97% torque and 9.7 cP viscosity ± 0.197 (closer to ± 0.2) cP. The accuracy is a combination of Viscometer and fluid tolerance (refer to **Interpretation of Calibration Test Results** at the end of this section).

- 4) With the viscometer stopped, remove the sample cup and place the viscosity standard fluid into the cup.
- 5) Connect the sample cup to the Viscometer. Allow sufficient time for temperature to reach equilibrium.
- 6) Measure the viscosity and record the Viscometer reading in both % torque and centipoise.

NOTE: The spindle must rotate at least five (5) times before readings are taken.

Interpretation of Calibration Test Results:

When verifying the calibration of the DV1, the instrument and viscosity standard fluid error must be combined to calculate the total allowable error.

The **DV1** is accurate to (+/-) 1% of any Full Scale spindle/speed viscosity range.

Brookfield Viscosity Standards Fluids are accurate to (+/-) 1% of their stated value.

Example 1:

Calculate the acceptable range of viscosity using DV1MRV with RV-3 Spindle at 2 RPM; Brookfield Standard Fluid 12,500 with a viscosity of 12,257 cP at 25°C:

- 1) Determine Full Scale Viscosity Range using the AUTORANGE key on your instrument or calculate with equation:

$$\text{Full Scale Viscosity Range [cP]} = \text{TK} * \text{SMC} * \frac{10,000}{\text{RPM}}$$

Where:

TK = 1.0 from **Table D-2** (In Appendix D)

SMC = 10 from **Table D-1** (In Appendix D)

$$\text{Full Scale Viscosity Range} \frac{1 * 10 * 10,000}{2} = 50,000 \text{ cP}$$

The viscosity is accurate to (+/-) 500 cP (which is 1% of 50,000).

- 2) The viscosity standard fluid is 12,257 cP. Its accuracy is (+/-) 1% of 12,257 or (+/-) 122.57 cP.
- 3) Total allowable error is (122.57 + 500) cP = (+/-) 622.57 cP.
- 4) Therefore, any viscosity reading between 11,634.4 and 12,879.6 cP indicates that the viscometer is operating correctly. Any reading outside these limits may indicate a viscometer problem. Contact the Brookfield technical sales department or your local authorized Brookfield dealer with test results to determine the nature of the problem.

Example 2:

Calculate the acceptable range of viscosity using DV1MRV with Small Sample adapter at 10 RPM; Brookfield Standard Fluid 12,500 with a viscosity of 12,257 cP at 25°C:

- 1) Determine Full Scale Viscosity Range by pressing the AUTORANGE key on your instrument. Display shows 25,000 cP. The viscosity is accurate to +/- 500 cP (which is 2% of 25,000 cP).
- 2) The viscosity standard fluid is 12,257 cP. Its accuracy is (+/-) 1% of 12,257 or (+/-) 122.57 cP.
- 3) Total allowable error is (122.57 + 500) cP = (+/-) 622.57 cP.
- 4) Therefore, any viscosity reading between 11,634.4 and 12,879.6 cP indicates that the viscometer is operating correctly. Any reading outside these limits may indicate a viscometer problem. Contact the Brookfield technical sales department or your local authorized Brookfield dealer with test results to determine the nature of the problem.

Appendix G - The Brookfield Guardleg

The guard leg was originally designed to protect the spindle during use. The first applications of the Brookfield Viscometer included hand held operation while measuring fluids in a 55-gallon drum. It is clear that under those conditions the potential for damage to the spindle was great. Original construction included a sleeve that protected the spindle from side impact. Early RV guard legs attached to the dial housing and LV guard legs attached to the bottom of the pivot cup with a twist and lock mechanism.

The current guard leg is a band of metal in the shape of the letter U with a bracket at the top that attaches to the pivot cup of a Brookfield Viscometer/Rheometer. Because it must attach to the pivot cup, the guard leg cannot be used with a Cone/Plate instrument. A guard leg is supplied with all LV and RV series instruments, but not with the HA or HB series. Its shape (shown in Figures G-1 and G-2) is designed to accommodate the spindles of the appropriate spindle set; therefore, the RV guard leg is wider than the LV due to the large diameter of the RV-1 and RV-2 spindles. The RV and LV guardlegs are not interchangeable.

The calibration of the Brookfield Viscometer/Rheometer is determined using a 600mL Low Form Griffin Beaker. The calibration of LV and RV series instruments includes the guard leg. The beaker wall (for HA/HB instruments) or the guard leg (for LV/RV instruments) defines what is called the “outer boundary” of the measurement. The spindle factors for the LV, RV, and HA/HB spindles were developed with the above boundary conditions. The spindle factors are used to convert the instrument torque (expressed as the dial reading or %Torque value) into centipoise. Theoretically, if measurements are made with different boundary conditions, e.g., without the guard leg or in a container other than 600 mL beaker, then the spindle factors found on the Factor Finder cannot be used to accurately calculate an absolute viscosity. Changing the boundary conditions does not change the viscosity of the fluid, but it does change how the instrument torque is converted to centipoise. Without changing the spindle factor to suit the new boundary conditions, the calculation from instrument torque to viscosity will be incorrect.

Practically speaking, the guard leg has the greatest effect when used with the #1 & #2 spindles of the LV and RV spindle sets (Note: RV/HA/HB #1 spindle is not included in standard spindle set). Any other LV (#3 & #4) or RV (#3 - #7) spindle can be used in a 600mL beaker with or without the guard leg to produce correct results. The HA and HB series Viscometers/Rheometers are not supplied with guard legs in order to reduce the potential problems when measuring high viscosity materials. HA/HB spindles #3 through #7 are identical to those spindle numbers in the RV spindle set. The HA/HB #1 & #2 have slightly different dimensions than the corresponding RV spindles. This dimensional difference allows the factors between the RV and HA/HB #1 & #2 spindles to follow the same ratios as the instrument torque even though the boundary conditions are different.

The recommended procedures of using a 600mL beaker and the guard leg are difficult for some customers to follow. The guard leg is one more item to clean. In some applications, the 500mL of test fluid required to immerse the spindles in a 600mL beaker is not available. In practice, a smaller vessel may be used and the guard leg is removed. The Brookfield Viscometer/Rheometer will produce an accurate and repeatable torque reading under any measurement circumstance. However, the conversion of this torque reading to centipoise will only be correct if the factor used was developed for those specific conditions. Brookfield has outlined a method for recalibrating a Brookfield Viscometer/Rheometer to any measurement circumstance in More Solutions to Sticky Problems. It is important to note that for many viscometer users the true viscosity is not as important as a repeatable day to day value. This repeatable value can be obtained without any special effort for any measurement circumstance. But, it should be known that this type of torque reading will not convert into a correct centipoise value when using a Brookfield factor if the boundary conditions are not those specified by Brookfield.

The guard leg is a part of the calibration check of the Brookfield LV and RV series Viscometer/Rheometer. Our customers should be aware of its existence, its purpose and the effect that it may have on data. With this knowledge, the viscometer user may make modifications to the recommended method of operation to suit their needs.

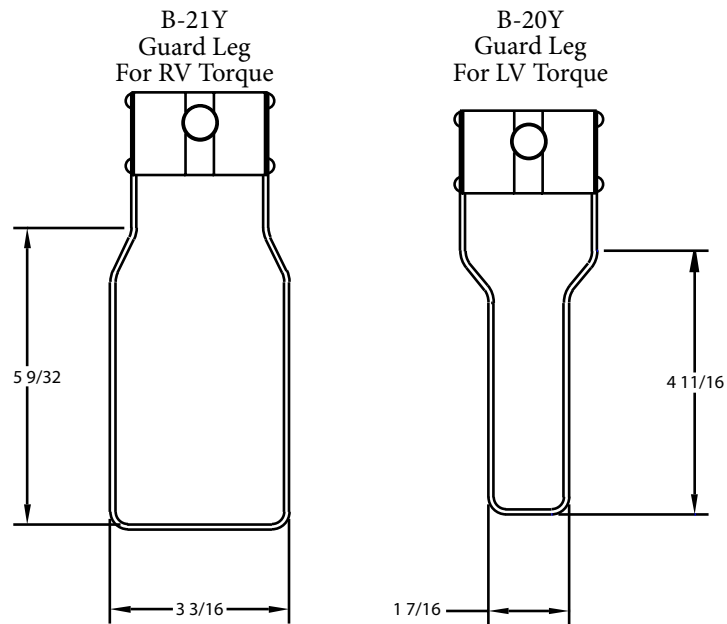

Figure G-1 - Brookfield Guard Leg

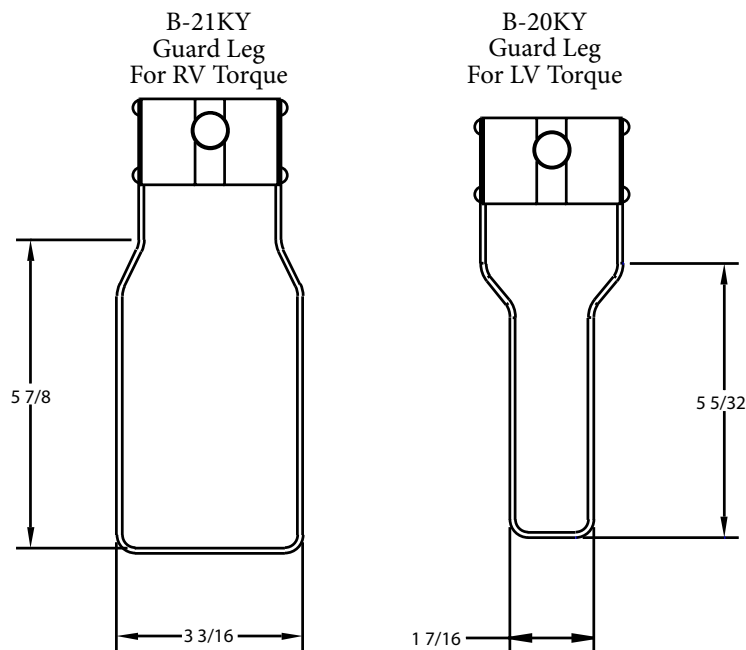
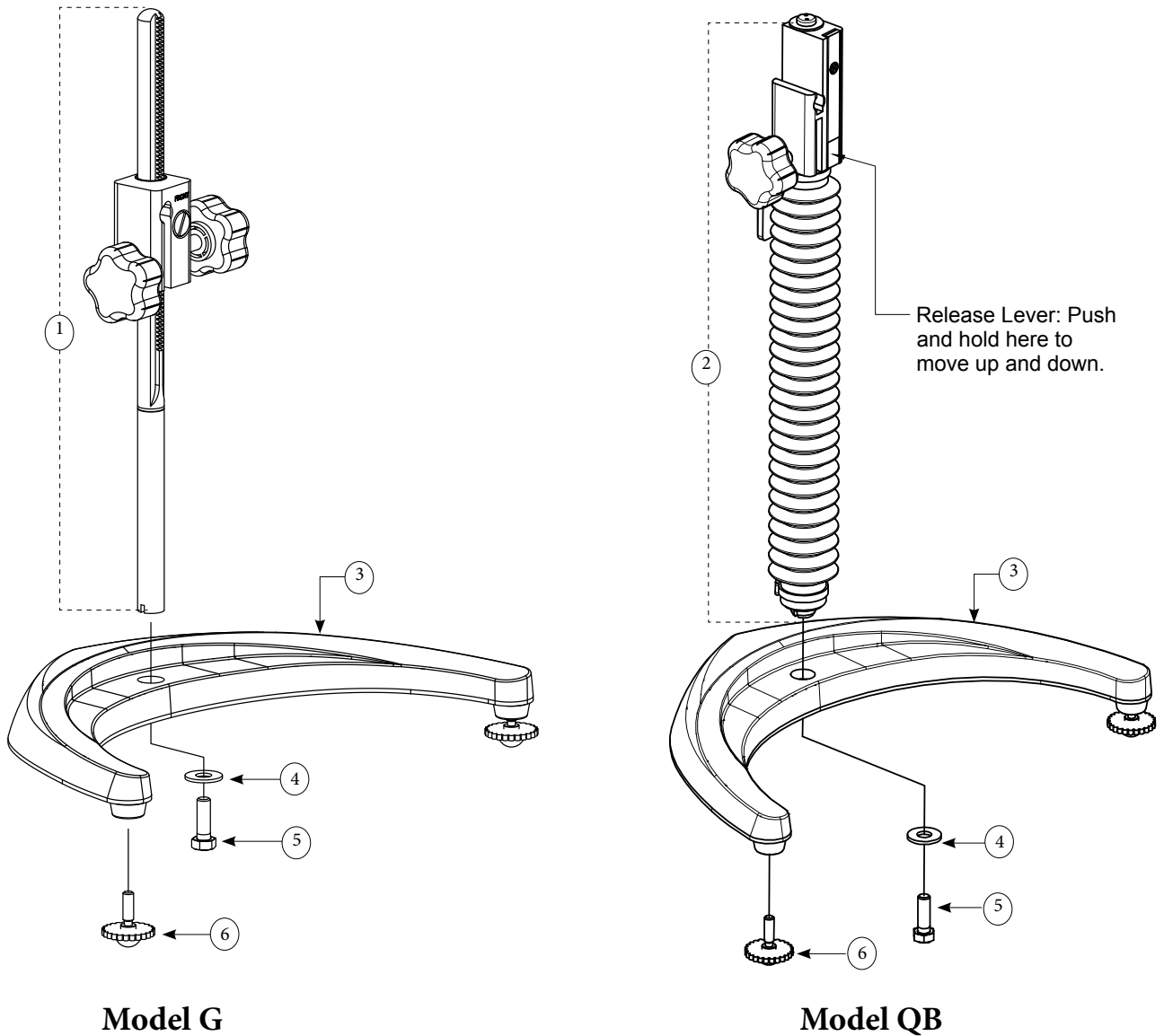

Figure G-2 - Brookfield EZ-Lock Guard Leg

Appendix H - Laboratory Stands with Parts Identification



Item	Part Number	Description	Qty.
1	VS-CRA-14S	Rod and Clamp Assembly (Model G)	1
2	VSQA-100	Rod and Clamp Assembly (Model QB)†	1
3	GV-1201	Base, Models G and QB (includes 2 VS-3 leveling screws)	1
4	502028071S33B	Flat washer 5/16 x 7/8 x .071"	1
5	50S311832S01B	Screw, 5/16-18 x 1" lg. hex head	1
6	GV-1203	Leveling Screws, Model G and QB	2/2

Figure H-1

UNPACKING

Check carefully to see that all the components are received with no concealed damage.

- 1 Base, with 2 Leveling Screws, packed in a cardboard carton
- 1 Upright Rod, with attached Clamp Assembly, Mounting Screw and Lock washer

ASSEMBLY

1. Remove the base assembly from the carton.
2. Remove the screw and washer from the upright rod. Place the rod and clamp assembly into the hole in the top of the base.

NOTE: The “Front” designation on the clamp assembly should face the opening of the legs, i.e., parallel to the leveling feet.

3. Rotate the rod/clamp assembly slightly until the slot on the bottom of the rod intersects the pin located in the base.
4. While holding the rod and base together, insert the slotted screw and washer, as shown in Figure H-1, and tighten securely.
5. Adjust the VS-28 tension screw on the clamp assembly so that it is not loose on the upright rod.

VISCOMETER MOUNTING

Insert the Viscometer mounting rod into the hole (with the cut-away slot) in the clamp assembly. Adjust the instrument level until the bubble is centered from right to left and tighten the clamp knob (clockwise). Use the leveling screws to “fine” adjust the viscometer level.

NOTE: If the Digital Viscometer cannot be leveled, check to insure that the rod is installed with the gear rack facing forward.

CAUTION: Do not tighten the clamp knob unless the viscometer mounting rod is inserted in the clamp assembly.

NOTE: If the clamp is taken off the upright rod, the tension insert (Part No. VS-29) must be properly aligned for the clamp to fit back onto the upright rod.

When the tension insert (Part No. VS-29) is inserted, its slot must be in the vertical position parallel to the upright rod. If the slot is not in the correct position, the clamp will not slide down over the upright rod. Use a small screwdriver or pencil to move it into the correct position.

Appendix I - DVE-50A Probe Clip

Probe Clip DVE-50A is supplied with the DV1 Optional Temperature Probe. It is used to attach the RTD temperature probe to the LV/RV Guard Leg or 600mL low form Griffin beaker. Figure I-1 is a view of the Probe Clip, showing the hole into which the RTD probe is inserted, and the slot which fits onto the LV/RV guard leg. When inserting the RTD probe into the Probe Clip, the upper part of the Clip is compressed by squeezing the points shown in Figure I-1.

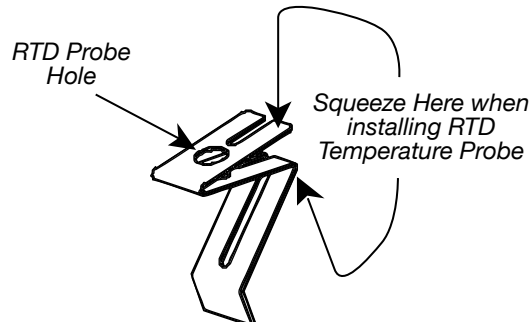

Figure I-1

Figure I-2 shows the Probe Clip (with RTD temperature probe installed) mounted on the guard leg.

Figure I-3 shows the Probe Clip mounted in a 600mL low form Griffin beaker. This mounting may be used with LV, RV, HA and HB series instruments.

NOTE: The RTD probe must be parallel to the beaker wall so as not to interfere with the viscosity measurement.

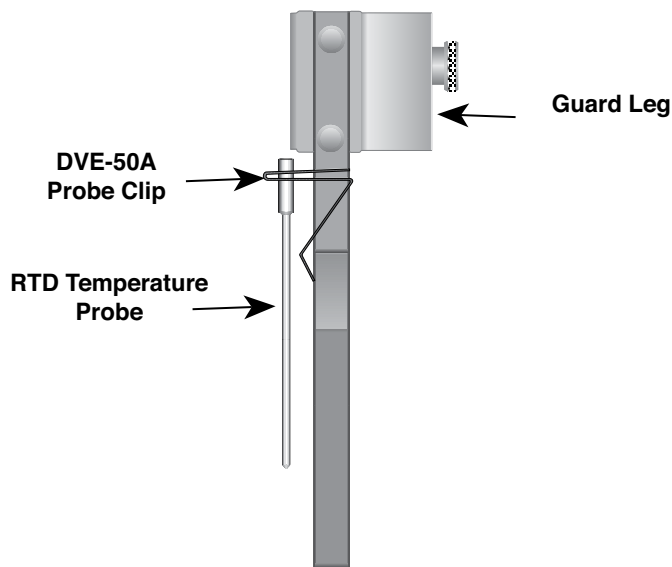

Figure I-2

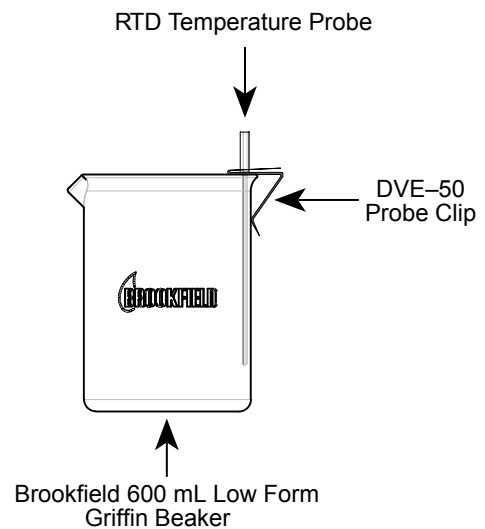

Figure I-3

Appendix J - Fault Diagnosis and Troubleshooting

Spindle Does Not Rotate

- Make sure the viscometer is plugged in.
- Check the voltage rating on your viscometer (115V, 220V): it must match wall voltage.
- Make sure the power switch is in the ON position.
- Verify rpm: make sure rotational speed (RPM) has been correctly selected.

Spindle Wobbles When Rotating or Looks Bent

- Make sure the spindle is tightened securely to the viscometer coupling.
- Check the straightness of all other spindles; replace them if bent.
- Inspect viscometer coupling and spindle coupling mating areas and threads for dirt: clean threads on spindle coupling with a 3/56 left-hand tap.
- Inspect threads for wear; if the threads are worn, the unit needs service (see Appendix L).
- Check to see if spindles rotate eccentrically or wobble. There is an allowable run-out for 1/32-inch in each direction (1/16-inch total) when measured from the bottom of the spindle rotating in air.
- Check to see if the viscometer coupling is bent; if so, the unit is in need of service.

If you are continuing to experience problems with your viscometer, follow this troubleshooting section to help isolate the potential problem.

Perform an Oscillation Check

- Remove the spindle and turn the **motor** OFF.
- Gently push up on the viscometer coupling.
- Turn the coupling until the % on the display reads 15% - 20%.
- Gently let go of the coupling.
- Watch the % values decrease and rest at 0.0 ($\pm 0.1\%$)

If the viscometer does not rest at zero, the unit is need of service. See Appendix L for details on how to return your viscometer.

Inaccurate Readings

- Verify Spindle, Speed and Model selection
- Verify test parameters: temperature, container, volume, and method. Refer to:
 - “More Solutions to Sticky Problems”; Chapter 3, Section 3.4, Viscosity Measurement Techniques
- Perform a calibration check. Follow the instructions in Appendix F.
 - Verify tolerances are calculated correctly.
 - Verify that calibration check procedures were followed exactly.

If the unit is found to be out of tolerance, the unit may be in need of service. See Appendix L for details on how to return your viscometer.

Appendix K - Online Help and Additional Resources

www.brookfieldengineering.com**

The Brookfield website is a good resource for additional information and self-help whenever you need it. Our website offers a selection of “how to” videos, application notes, conversion tables, instruction manuals, material safety data sheets, calibration templates and other technical resources.

<http://www.youtube.com/user/BrookfieldEng>

Brookfield has its own YouTube channel. Videos posted to our website can be found here as well as other “home-made” videos made by our own technical sales group.

Viscosityjournal.com

Brookfield is involved with a satellite website that should be your first stop in viscosity research. This site serves as a library of interviews with experts in the viscosity field as well as Brookfield technical articles and conversion charts. Registration is required so that you can be notified of upcoming interviews and events, however, this information will not be shared with other vendors, institutions, etc.

Article Reprints

- Available in Print Only
- Brookfield has an extensive library of published articles relating to viscosity, texture and powder testing. Due to copyright restrictions, these articles cannot be emailed. Please request a hardcopy of articles by calling our customer service department or by emailing: marketing@brookfieldengineering.com.
- Available online
- Brookfield has a growing number of published articles that can be downloaded directly from the Brookfield website. These articles can be found on our main website by following this path: [http://www.brookfieldengineering.com/support/documentation/article reprints](http://www.brookfieldengineering.com/support/documentation/article-reprints)

More Solutions To Sticky Problems

Learn more about viscosity and rheology with our most popular publication. This informative booklet will provide you with measurement techniques, advice and much more. It's a must-have for any Brookfield Viscometer or Rheometer operator. More Solutions is available in print and/or as a downloadable pdf on the Brookfield website by following this path:

<http://www.brookfieldengineering.com/support/documentation>

Training/Courses

Whether it is instrument-specific courses, training to help you better prepare for auditing concerns, or just a better understanding of your methods, who better to learn from than the worldwide leaders of viscosity measuring equipment? Visit our Services section on our website to learn more about training.

**Downloads will require you to register your name, company and email address. We respect your privacy and will not share this information outside of Brookfield.

Appendix L - Warranty Repair and Service

Warranty

Brookfield Viscometers are guaranteed for one year from date of purchase against defects in materials and workmanship. They are certified against primary viscosity standards traceable to the National Institute of Standards and Technology (NIST). The Viscometer must be returned to **Brookfield Engineering Laboratories, Inc.** or the Brookfield dealer from whom it was purchased for a warranty evaluation. Transportation is at the purchaser's expense. The Viscometer should be shipped in its carrying case together with all spindles originally provided with the instrument. If returning to Brookfield, please contact us for a return authorization number prior to shipping. Failure to do so will result in a longer repair time.

*For a copy of the Repair Return Form, go to the Brookfield website,
www.brookfieldengineering.com*

For repair or service in the **United States** return to:

Brookfield Engineering Laboratories, Inc.
11 Commerce Boulevard
Middleboro, MA 02346 U.S.A.

Telephone: (508) 946-6200 FAX: (508) 923-5009
www.brookfieldengineering.com

For repair or service outside the United States consult Brookfield Engineering Laboratories, Inc. or the dealer from whom you purchased the instrument.

For repair or service in the **United Kingdom** return to:

Brookfield Viscometers Limited
Brookfield Technical Centre
Stadium Way
Harlow, Essex CM19 5GX, England

Telephone: (44) 1279/451774 FAX: (44) 1279/451775
www.brookfield.co.uk

For repair or service in **Germany** return to:

Brookfield Engineering Laboratories Vertriebs GmbH
Hauptstrasse 18
D-73547 Lorch, Germany

Telephone: (49) 7172/927100 FAX: (49) 7172/927105
www.brookfield-gmbh.de

For repair or service in **China** return to:

Guangzhou Brookfield Viscometers and Texture Instruments Service Company Ltd.
Suite 905, South Tower, Xindacheng Plaza
193 Guangzhou Da Dao Bei, Yuexiu District
Guangzhou, 510075 P. R. China

Telephone: (86) 20/3760-0548 FAX: (86) 20/3760-0548
www.brookfield.com.cn

On-site service at your facility is also available from Brookfield. Please contact our Service Department in the United States, United Kingdom, Germany or China for details.

