

# Operating Manual

## Programmable Controller LC6

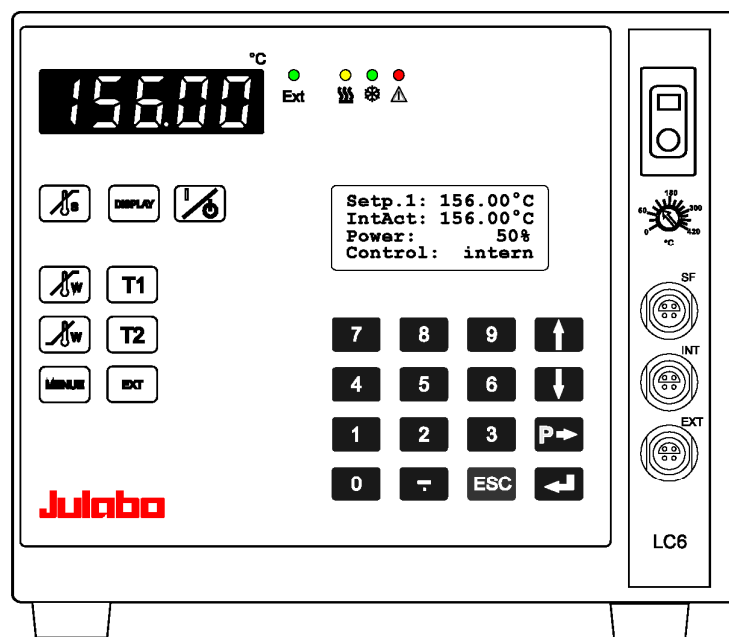

Distributed by:



**Carl Stuart Limited**

ADVANCED APPLIED TECHNOLOGIES

Contact Us:

Irl Ph: 01 4523432

UK Ph: 08452 30 40 30

Web: [www.carlstuart.com](http://www.carlstuart.com)

Email: [info@carlstuart.com](mailto:info@carlstuart.com)

Printed in Germany

Changes without prior notification reserved

1.951.5220BE4 12/05

# Julabo

JULABO Labortechnik GmbH  
Eisenbahnstraße 45  
D-77960 Seelbach / Germany



+49-7823 / 51-0



+49-7823 / 2491



[info@julabo.de](mailto:info@julabo.de)



[www.julabo.de](http://www.julabo.de)

---

## Congratulations!

You have made an excellent choice.

JULABO thanks you for the trust you have placed in us.

This operating manual has been designed to help you gain an understanding of the principles of operating and possibilities of our circulators. For optimum utilization of all functions, we recommend that you thoroughly study this manual prior to beginning operation.

## Safety Warnings

Take care your unit is operated only by qualified persons.

Make sure you read and understand all instructions and safety precautions listed in this manual before installing or operating your unit. If you have any questions concerning the operation of your unit or the information in this manual, contact JULABO.

Performance of installation, operation, or maintenance procedures other than those described in this manual may result in a hazardous situation and may void the manufacturer's warranty.

Transport the unit with care. Sudden jolts or drops may cause damages in the interior of the unit.

Observe all warning labels.

Never remove warning labels.

Never operate damaged or leaking equipment.

Never operate the unit without bath fluid in the bath.

Always turn off the unit and disconnect the mains cable from the power source before performing any service or maintenance procedures, or before moving the unit.

Never operate equipment with damaged mains power cables.

Refer service and repairs to a qualified technician.

























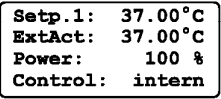

In addition to the safety warnings listed above, warnings are posted throughout the manual. These warnings are designated by an exclamation mark inside an equilateral triangle. Read and follow these important instructions. Failure to observe these instructions can result in permanent damage to the unit, significant property damage, personal injury or death.



## TABLE OF CONTENTS

---







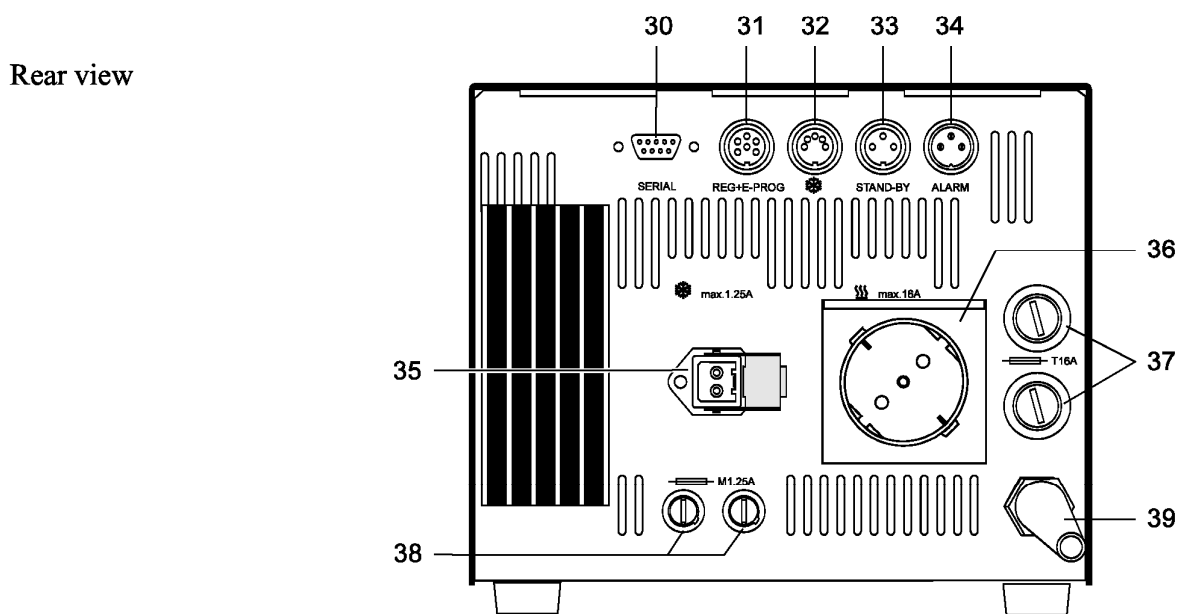

1. Operating controls and functional elements.....	4
2. Unpacking and checking.....	6
3. Description.....	6
4. Quality Management System.....	6
5. Preparations .....	7
5.1. Setup.....	7
5.2. Connecting a heating device .....	7
5.3. Connecting the temperature sensors.....	8
5.4. Controlling an intermittent cooling water supply .....	8
5.5. Applications .....	9
6. Operating procedures .....	11
6.1. Power connection .....	11
6.2. Switching on / Selecting the language .....	11
7. Manual operation .....	12
7.1. Start - Stop .....	12
7.2. Setting the temperatures .....	12
7.3. Warning functions.....	13
7.4. Setting the safety temperature (with shutdown function).....	14
7.5. Internal / external control.....	15
8. Menu functions .....	16
8.1. Configuration .....	17
8.2. Control parameters.....	20
8.3. Start of a profile .....	21
8.4. Integrated programmer.....	24
8.5. Analog inputs/outputs .....	27
8.6. Limits .....	30
8.7. Interface .....	30
8.8. Sensors .....	31
9. Troubleshooting guide / Error messages .....	32
10. Safety recommendations .....	33
11. Electrical connections .....	34
12. Remote control.....	37
12.1. Setup for remote control .....	37
12.2. Communication with a PC or a superordinated data system .....	37
12.3. List of commands .....	39
12.4. Status messages / error messages .....	42
13. Cleaning the unit .....	44
14. Maintenance .....	44
15. Technical specifications .....	45
16. EC Declaration of Conformity.....	47
17. Warranty conditions .....	48

# 1. Operating controls and functional elements

- |    |   |   |
|----|---|---|
| 1  |    | Mains power switch, illuminated   |
| 2  |    | Start / stop key  |
| 3  |    | Working temperature T1  |
| 4  |    | Working temperature T2  |
| 5  |    | High temperature warning limit  |
| 6  |    | Low temperature warning limit   |
| 7  |    | Safety temperature  |
| 8  |    | Adjustable excess temperature protection (safety temperature)           |
| 9  |    | Control type: internal/external control                                 |
| 10 |    | MULTI-DISPLAY (LED) temperature indication                              |
| 11 |    | Display of internal/external actual value                               |
|    | <u>Indicator lights:</u>  |   |
|    | Ext   | Temperature indication - external actual value                          |
|    |    | Alarm / Cooling / Heating   |
| 12 |    | DIALOG-DISPLAY (LCD) for indication of:                                 |
|    | Line 1: Setpoint  or  or  or  |   |
|    | Line 2: Internal or external actual value    |   |
|    | Line 3: Heating power in %  |   |
|    | Line 4: Control type: internal /  external control   |   |
| 13 |    | MENUE key - for selecting the menu functions                            |
| 14 |    | Cursor keys - Select menu items   |
| 15 |    | P-key            Selecting parameters                                   |
| 16 |    | Numeral keypad: numerals 0 to 9; minus / decimal point                  |
| 17 |    | Enter key        1) Store value / parameter<br>2) Next lower menu level |
| 18 |    | Escape key       1) Cancel entries<br>2) Return to a higher menu level  |

- 19  SF Socket for safety sensor
- 20  INT Socket for internal measurement and control sensor
- 21  EXT Socket for external measurement and control sensor



- 30  SERIAL Interface RS232/RS485
- 31  REG+E-PROG Programmer input and temperature recorder output
- 32  Socket: control cable of JULABO refrigerated circulator or output for alarm messages
- 33  STAND-BY Stand-by input (for external emergency switch-off)
- 34  ALARM Alarm output (for external alarm signal)
- 35  Control output for solenoid valve  
230 V / 115 V
- 36  Grounded mains socket for heating device  
(max. resistive load 3000 W)
- 37  Mains fuses
- 38  Fuses (for connectors 35)
- 39 Mains power cable with plug

## 2. Unpacking and checking

Unpack the programmable controller and accessories and check for damages incurred during transit. These should be reported to the responsible carrier, railway, or postal authority, and a request for a damage report should be made. These instructions must be followed fully for us to guarantee our full support of your claim for protecting against loss from concealed damage. The form required for filing such a claim will be provided by the carrier.

## 3. Description

Fulfilling its principle task, reliable temperature control and measurement, the LC6 temperature controller also implements safety and monitoring functions, particularly in the areas of chemical research and quality control. The sophisticated capabilities of the unit allow wide application with electrical heating devices such as

heating hoods, heating baths,  
heating pads and bandages,  
water and oil baths.

Setting is rapid and simple using the keypad with its easy to learn symbols. Keypad is splash-proof, easily cleaned and ergonomically designed.

The microprocessor technology allows four temperature values to be stored and indicated on the DIALOG-DISPLAY (LCD): working temperatures T1 and T2, high and low temperature warning limits.

The safety value for excess temperature protection, a safety installation independent from the control circuit, is adjustable on the front with simultaneous indication on the MULTI-DISPLAY (LED).

The RS232/RS485 port permits modern process engineering without additional interface, directly on-line, from the circulator to your application equipment.

Besides the digital interface, additionally analog connectors are provided, such as for Pt100 external sensor, analog programmer input, temperature recorder output and others.

## 4. Quality Management System



### The JULABO Quality Management System:

Development, production and distribution of temperature application instruments for research and industries conform to requirements according to DIN EN ISO 9001:1994-08.

Certificate Registration No. QA 051004008.

## 5. Preparations

### 5.1. Setup



The unit should be set up at a dry location.

Place the unit in an upright position and do not obstruct the ventilation.

A wall distance of at least 10 cm must be maintained for ventilation, allowing internal heat to be conducted away from the unit.

If one or more temperature controllers are set up in a cabinet for example, take care of good ventilation (waste heat per unit = approx. 60 Watts).

The ambient temperature must not exceed 35 °C. Ambient temperatures above 35 °C result in a failure of the unit.

Do not set up the unit in the immediate vicinity of heat sources and do not expose to sun light.

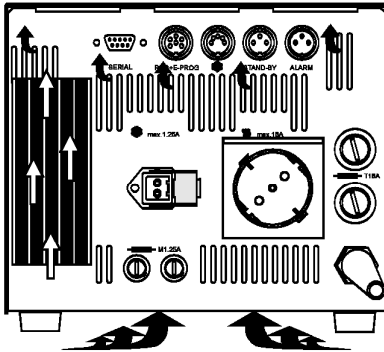

### 5.2. Connecting a heating device



**Set up the heating device according to the instructions or securely fix the unit in the bath tank using appropriate means. Danger of burning and fire!**

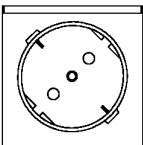

Connect the power plug to the grounded mains socket (36) on the rear of the programmable controller.



**Max. resistive load 3000 W at 230 V.  
Max. current 16 A.**

### 5.3. Connecting the temperature sensors

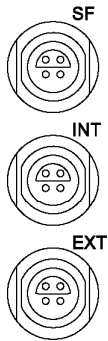

To avoid error message and safety shutdown (see page 32), attach sensors “SF” and “INT” before switching the instrument ON.

- Attach the working sensor to socket labeled “INT” and the safety sensor to socket labeled “SF”.

#### Sensor calibration:

When the controller is first placed into operation or whenever a sensor is replaced, a working sensor calibration must be carried out (ATC - see page 31).



**Place both sensors into the bath medium and securely fix the sensors.**

### 5.4. Controlling an intermittent cooling water supply

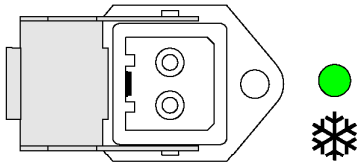

The control output (35) is intended for the attachment of a solenoid valve (230 V or 115 V - max. 1.25 A) which can be used to control the flow of a liquid coolant. The flow of a coolant is indicated by the illumination of a green indication light on the control panel of LC6.

The solenoid valve is designed to be attached to the coolant supply line.



**Fasten tubing to prevent slipping.**

Order-No.	Description
8 980 703-3	Solenoid valve (230 V)
8 980 703-2	Solenoid valve (115 V)



## 5.5. Applications

### Controlling an open bath with a direct heating device and internal control:

- A heating device is used to heat the bath fluid.
- Both the measurement and control sensor „INT“ and the safety sensor „SF“ must be connected to the LC6 and immersed in the bath.
- If a bath is to be operated at or near the ambient temperature, countercooling may be necessary to ensure bath stability. This is accomplished by circulating a coolant such as tap water through a cooling coil immersed in the bath. The flow of the coolant is controlled automatically by the solenoid valve.

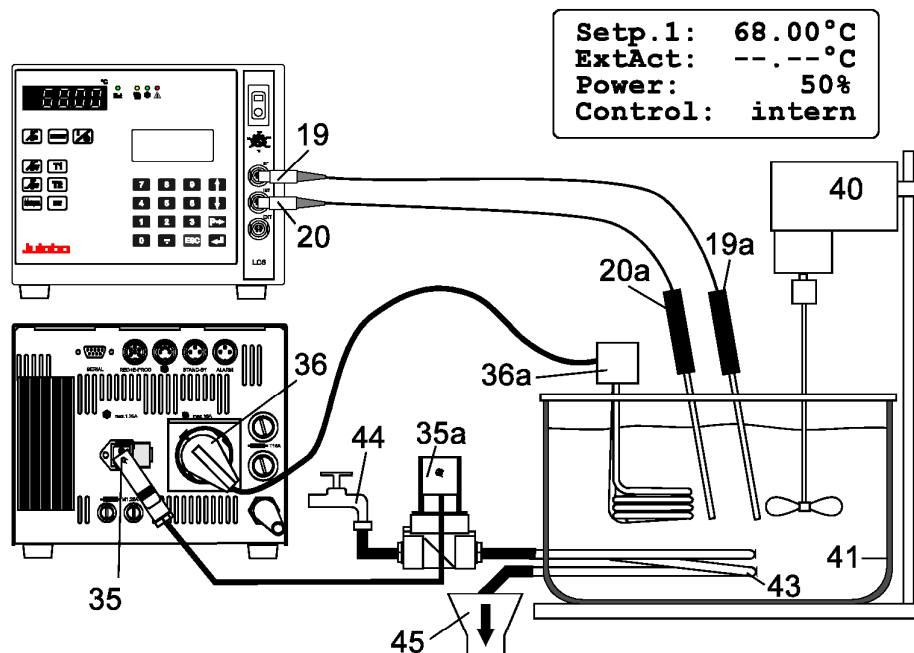

- |    |                                    |     |                                |
|----|------------------------------------|-----|--------------------------------|
| 19 | Connector „SF“                     | 19a | Safety sensor                  |
| 20 | Connector „INT“                    | 20a | Measurement and control sensor |
| 21 | Connector „EXT“                    | 20b | Measurement sensor             |
|    |                                    | 21a | Measurement and control sensor |
| 35 | Connector for solenoid valve       | 35a | Solenoid valve                 |
| 36 | Mains socket for heating device    | 36a | Heating device / heating hood  |
| 43 | Cooling coil                       |     |                                |
| 44 | Tap water connection               |     |                                |
| 45 | Cooling water drain                |     |                                |
| 40 | Stirrer motor for bath circulation |     |                                |
| 41 | Bath tank                          |     |                                |
| 42 | Round bottom flask                 |     |                                |

**Controlling an open bath with an indirect heating device and internal control:**

- The bath fluid is heated with a device providing indirect heat, such as a heating hood.
- Both the measurement and control sensor „INT“ and the safety sensor „SF“ must be connected to the LC6 and immersed in the bath.

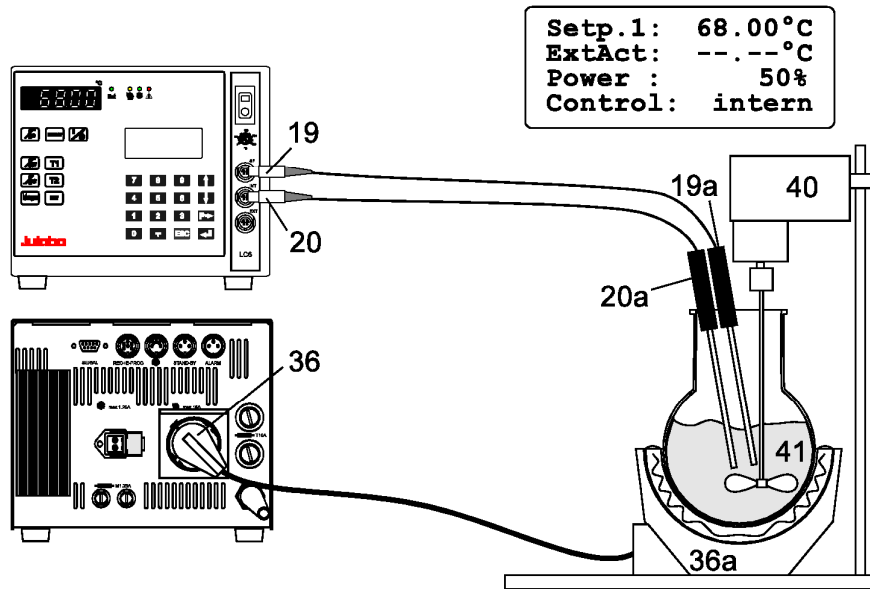

**Controlling an open bath with an indirect heating device and external control:**

- The bath liquid is heated indirectly with a water bath for example.
- The measurement „INT“ and safety „SF“ sensors must be immersed in the water bath.
- The measurement and control sensor „EXT“ must be immersed in the external bath liquid.

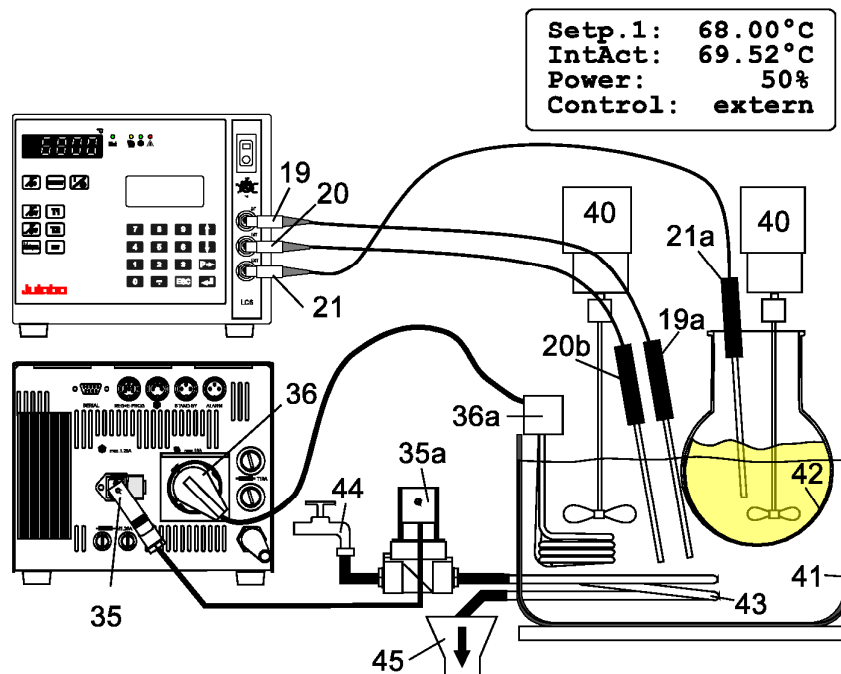

## 6. Operating procedures

### 6.1. Power connection



**Connect the unit only to a grounded mains power socket!  
We disclaim all liability for damage caused by incorrect line voltages!**

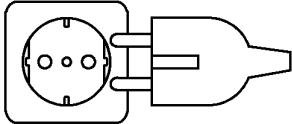

Check to make sure that the line voltage matches the supply voltage specified on the identification plate.

Deviations of  $\pm 10\%$  are permissible.

### 6.2. Switching on / Selecting the language



JULABO  
HighTech  
Laborregler  
Version 1.11

-OFF-

#### Switching on:

Turn on the mains power switch.

The unit performs a self-test.

All segments of the 5-digit MULTI-DISPLAY (LED), all indicator lights and the DIALOG-DISPLAY (LCD) will illuminate.

Then the software version (example: n 1.11) appears. The display "OFF" indicates the unit is ready to operate (standby mode).





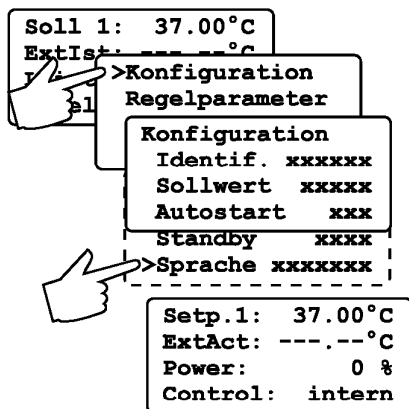

The programmable controller enters the operating mode activated before switching the programmable controller off: **keypad control mode** (manual operation) or **remote control mode** (operation via personal computer).

#### Selecting the language:

There are two options for the language of the DIALOG-DISPLAY (LCD): German or English. Select the desired language in the MENUE level under the configuration submenu.



Press the respective keys in the following order:

1. MENUE key  1 x
2. Enter key  1 x
3. Cursor key  4 x
4. P key  1 x
5. Enter key  1 x
6. Escape key  2 x

The DIALOG-DISPLAY (LCD) helps to follow up the individual settings. (example: swap the language from German to English.)

## 7. Manual operation

### 7.1. Start - Stop



21.03

**Start:**

- Press the start/stop key .  
The MULTI-DISPLAY (LED) indicates the actual bath temperature. (example: 21.03 °C)

-OFF-

**Stop:**

- Press the start/stop key .  
The MULTI-DISPLAY (LED) indicates the message "OFF".



The unit also enters the safe operating state "OFF" or "r OFF" after a mains power interruption. The temperature values entered via the keypad remain in memory. With the programmable controller in keypad control mode, press the start/stop key to restart operation. With the programmable controller in remote control mode, the personal computer must first resend the parameters set via the interface before the circulator may be restarted.

### 7.2. Setting the temperatures



Setp. 1: 50.00°C  
ExtAct: xxxxxx°C  
Power: x %  
Control: xxxxxx





Setp. 1: 37.00°C  
ExtAct: xxxxxx°C  
Power: x %  
Control: xxxxxx



Setp. 2: 25.50°C  
ExtAct: xxxxxx°C  
Power: x %  
Control: xxxxxx

This setting may be carried out with the programmable controller being in operating state Start or Stop!



#### Setting the working temperature "T1":

- ① Press the setpoint key .  
The value previously set appears on the DIALOG-DISPLAY (LCD) (example: 50.00°C).  
A flashing segment indicates that a value needs to be entered.
- ② Use the keypad to enter the new value (example: 37.00 °C).
- ③ Press enter  to store the selected value.

#### Setting the working temperature "T2":

- ① Press the setpoint key .
- ② Follow the instructions
- ③ for "T1" (example: 25.50 °C).

### Selecting the working temperature:

- Press the setpoint key **T1** and then enter .
- Press the setpoint key **T2** and then enter .

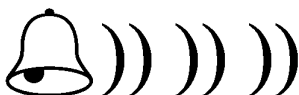

### 7.3. Warning functions

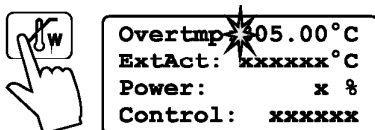

More protection for your samples in the bath!  
An audible signal sounds in intervals when the actual temperature value exceeds one of the set limits (patented).



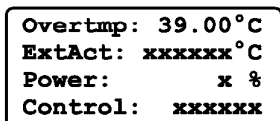

### Setting the high temperature limit:

- ① Press the key .
- The value previously set appears on the DIALOG-DISPLAY (LCD) (example: 305.00°C). A flashing segment indicates that a value needs to be entered.
- ② Use the keypad to enter the new value (example: 39.00 °C).
- ③ Press enter  to store the value.



### Setting the low temperature limit:

- ① Press the key .
- ② Follow the instructions
- ③ for  (example: 35.00 °C).

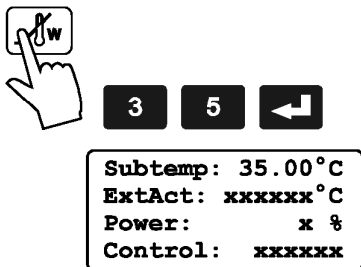

#### Note:

The warning functions will only be triggered when the actual bath temperature, after start from the „OFF“ or „rOFF“ mode, lies within the set limits for 3 seconds.

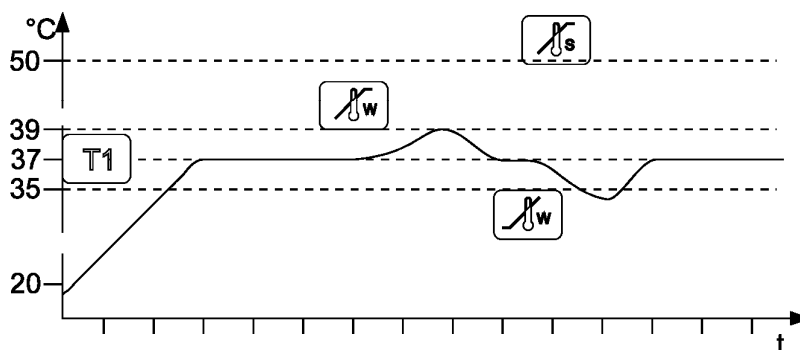

### 7.4. Setting the safety temperature (with shutdown function)

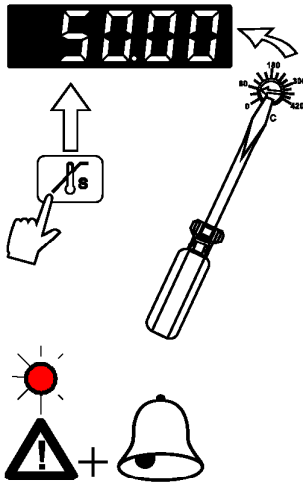

(excess temperature protection)

- Press the key to indicate the safety temperature value on the MULTI-DISPLAY and using a screwdriver simultaneously turn the setting screw to the desired value (example: 50 °C).

**Setting range:** 0 °C to 420 °C  
in 2 °C steps

This safety device is independent of the control circuit. If the temperature of the bath liquid reaches the safety temperature, a complete shutdown of the controlled heating device is effected. The alarm is indicated by optical and audible signals (continuous tone).

On the MULTI-DISPLAY (LED) and DIALOG-DISPLAY (LCD) appears the error message "E 14".

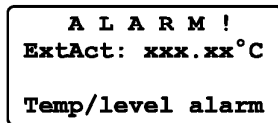

Cancel the alarm state (see page 32).

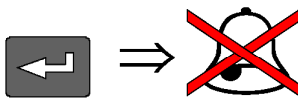

**Recommendation:**

Set the safety temperature at 5 to 10 °C above the working temperature setpoint.

	<b>The excess temperature protection should be set at least 25 °C below the fire point of the bath liquid used.</b>
	<b>In the event of wrong setting there is a fire hazard!</b>
	<b>We disclaim all liability for damage caused by wrong settings!</b>

## 7.5. Internal / external control

The programmable controller offers the possibility of internal temperature control in a primary bath vessel or external control directly in an external system.





ext. Pt100

### Setup for external control:

Connect a Pt100 sensor to the socket „EXT“ of the programmable controller, if necessary perform a calibration using the „ATC Ext.“ function (see page 31) and then securely fix the sensor in the external system.

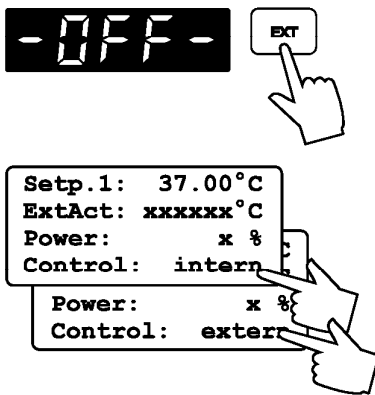
### Switching from internal to external control:



- Press the key  in operating state “OFF“ to select the control type.

- The DIALOG-DISPLAY (LCD) indicates the effective control type.



- Press the start/stop key .

### Temperature indication:

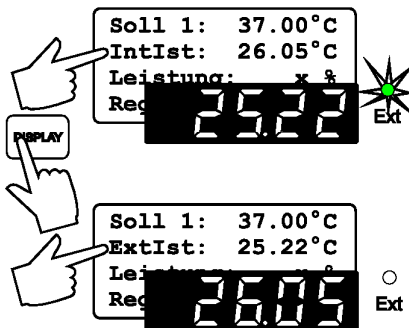





- Both actual temperatures are indicated at the same time:
  - 1) on the MULTI-DISPLAY (LED)
  - 2) on the DIALOG-DISPLAY (LCD).

- Press the key  to swap the values on the displays. The indicator light „Ext“ refers to the indication on the MULTI-DISPLAY (LED).



**Place the external sensor into the bath medium and securely fix the sensor.**

## 8. Menu functions

- Press the **MENUE** key  to enter the menu level.
- Use the up/down cursor keys   to select the desired submenu and press enter .
- Press escape **ESC** to return to the previous menu level.

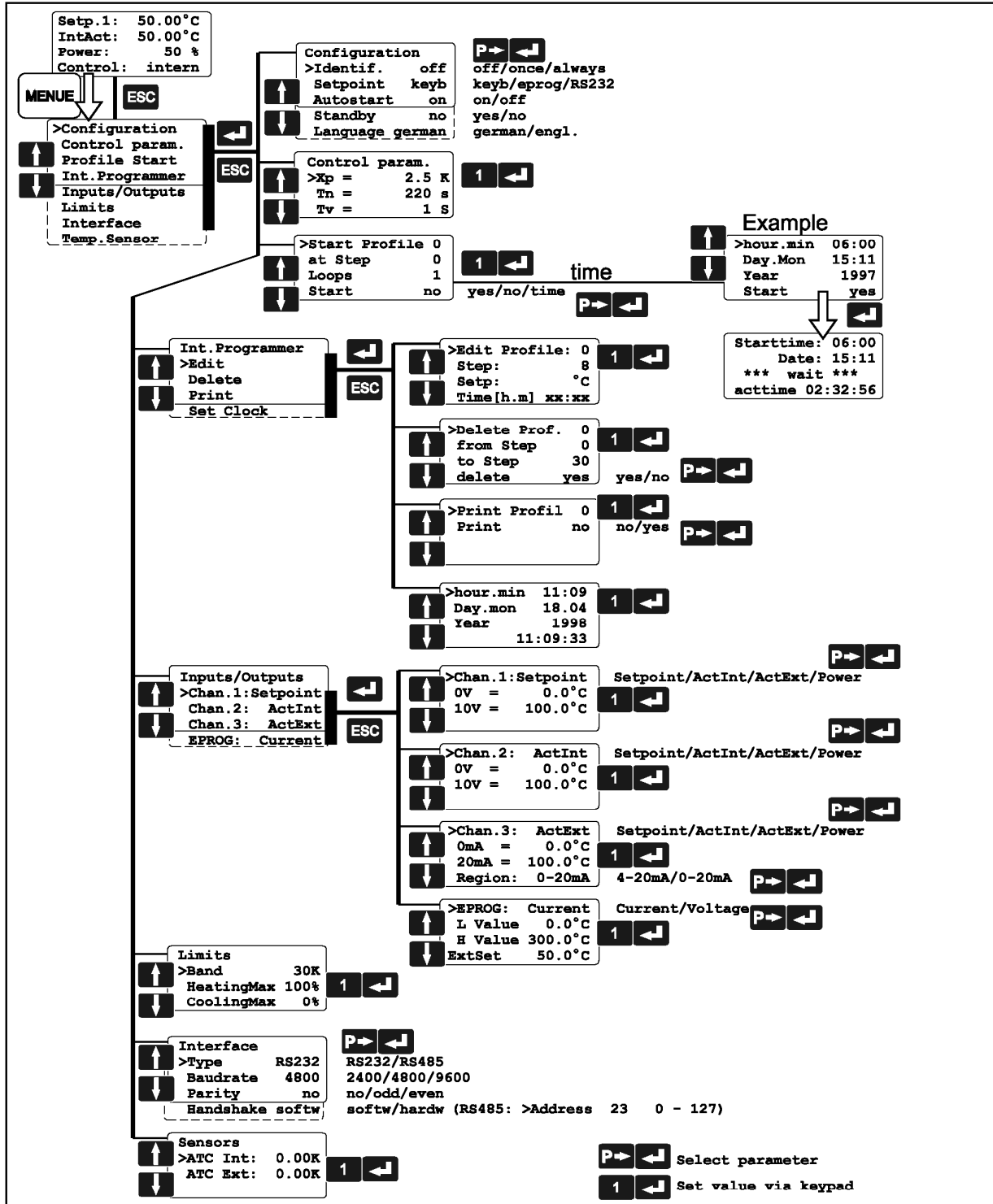







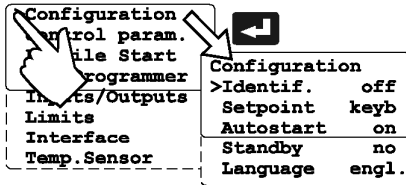

## 8.1. Configuration

By means of the configuration functions, operation of the programmable controller can be optimized for the current application.



- Press enter  to select the configuration submenu.
- Use the up/down cursor keys   to select the desired option. A flashing line indicates that a value needs to be entered.
- Press the P-key  to select the parameter and press enter .
- Press escape  to return the previous menu level.

### Identification

When performing an identification for the controlled system (temperature application system), the control parameters  $X_p$ ,  $T_n$  and  $T_v$  will be automatically determined and stored.

#### Possible parameters:

**off** - no identification.

The control parameters ascertained during the last identification are used for control purposes.

**once** - single identification

The programmable controller performs a single identification of the controlled system after start. After the identification process the parameter is automatically set to “off”.

**always** - continual identification

The programmable controller performs an identification of the controlled system whenever a new setpoint is to be reached.

**NOTE:** Use this setting only when the temperature application system changes permanently.

**Note:**

Requirement for an identification of the controlled system:

- The programmable controller must heat to a setpoint temperature at least 10 °C above the previous setpoint using the adjusted heating power.
- When the adjusted control parameters  $X_p$ ,  $T_n$  and  $T_v$  are too high, this requirement may not be given with respect to on how much the setpoint temperature has to change. In this case, prior to carrying out an identification in the „OFF“ state, set the control parameters to lower values.

Recommended setting for internal control:

$$X_p = 1.0 \text{ } ^\circ\text{C}$$

$$T_n = 80 \text{ s}$$

$$T_v = 8 \text{ s}$$

**Setpoint**

The programmable controller provides three possibilities for the setpoint selection. The selected mode is indicated on the DIALOG-DISPLAY (LCD).

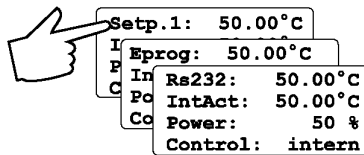

**Possible parameters:**

**keyb-** via keypad (working temperature  $T_1$  or  $T_2$ ) or via the integrated programmer.

**eprog** - via the analog interface REG+E-PROG (21) through an external programmer.

**RS232** - via the serial RS232/RS485 interface (20) through a PC or superordinated data system.



REG+E-PROG



SERIAL

---

## Autostart

### **Note:**

The programmable controller has been configured and supplied by JULABO according to N.A.M.U.R. recommendations. This means for the start mode, that the unit must enter a safe operating state after a power failure (non-automatic start mode). This safe operating state is indicated by „OFF“ or „rOFF“, resp. on the MULTI-DISPLAY (LED). A complete shutdown of the main functional elements such as heater and circulation pump is effected simultaneously.

Should such a safety standard not be required, the AUTOSTART function (automatic start mode) may be activated, thus allowing the start of the programmable controller directly by pressing the mains power switch or using a timer.

### Possible parameters:

**on** - AUTOSTART on

**off** - AUTOSTART off



### **Warning:**

**For supervised or unsupervised operation with the AUTOSTART function, avoid any hazardous situation to persons or property.**

**The programmable controller does no longer conform to N.A.M.U.R. recommendations.**

**Take care you fully observe the safety and warning functions of the programmable controller.**

## Stand-by input

External stand-by for emergency switch-off  
(connector - see page 36)

### Possible parameters:

**no** - stand-by input is ignored

**yes** - stand-by input is active

## Language

There are two options for the language of the DIALOG-DISPLAY (LCD): German or English.

### Possible parameters:

**German (deutsch)**

**English (engl.)**



STAND-BY

## 8.2. Control parameters

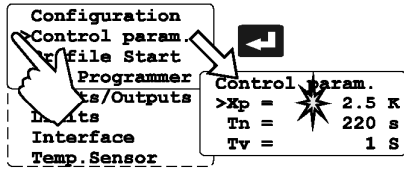

Xp = **2** **=** **5** **↵**

When performing an identification for the controlled system (temperature applications system) (see page 17), the control parameters Xp, Tn, and Tv will be automatically determined and stored.

Each parameter may be manually set via the keypad if necessary, to allow optimum control performance.

- Press enter **↵** to select the submenu „control parameters“.
- Use the up/down cursor keys **↑** **↓** to select the desired option. A flashing segment indicates that a new value needs to be entered.
- Use the numeral keypad to set the value and then set with enter **↵** (example: Xp = 2.5 °C).
- Press escape **ESC** to return to the previous menu level.

### Optimization instructions for the PID control parameters:

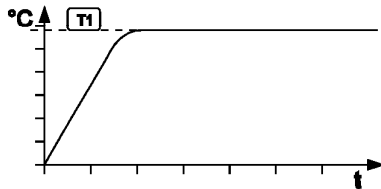

The heat-up curve reveals inappropriate control settings. (example: working temperature T1)

optimum setting

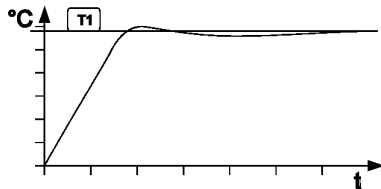

Inappropriate settings may produce the following heat-up curves:

Xp too low

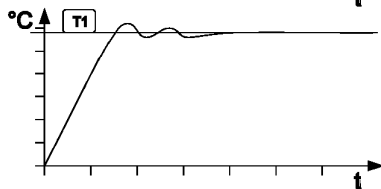

Tv/Tn too low

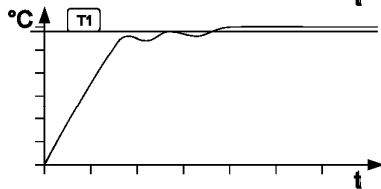

Xp too high  
or  
Tv too high

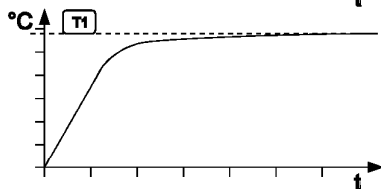

Tv/Tn too high  
or  
Xp too high

### 8.3. Start of a profile

The start menu of the programmable programmer allows calling up and defined starting of one of six previously stored temperature profiles.

**There are two possibilities for manually starting a program:**







1. Starting a program from the OFF status:

The programmer switches back to the OFF status at the end of the program.

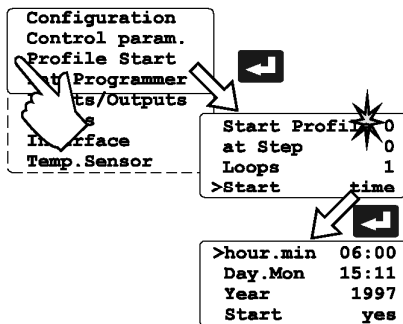
2. Starting a program from the operating status.

The programmer is started with the Start key , and the bath is heated to the desired temperature, for example 100 °C. At the end of the program, the programmer switches to the operating status and holds the bath temperature stable at 100.00 °C.



- Press enter  to select the submenu „Profile Start“.
- Use the up/down cursor keys   to select the desired option.



A flashing segment indicates that a number needs to be entered.

**Start Profile**      0 to 5  
**at Step**            0 to 60  
**Loops**                1 to 99

Enter the desired number and set each entry with enter .

**Start**                    no / yes ⇒ (manual start)  
 or  
                               time    ⇒ (via integrated timer)

A flashing line indicates that a parameter needs to be entered.

Press the P-key  to select the respective parameter and press enter .

Example: hour.min 6:00 h

0 6 - 0 0 ↵

```
>hour.min 06:00
Day.Mon 15:11
Year 1997
Start yes
```

```
Starttime: 06:00
Date: 15:11
*** wait ***
acttime 02:32:56
```

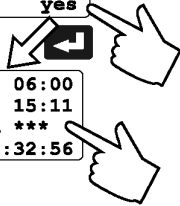

- When selecting the parameter **time**, a new menu level is called up for entry of the start time. A flashing segment indicates that a start time needs to be entered.

**hour.min** Start time  
**Day.Mon** day and month  
**Year** year

Set each entry with enter ↵.

**Start** no / yes

A flashing line indicates that the parameter „yes“ needs to be entered.

Press the P-key **P->** to select the parameter and press enter ↵.

- The programmable controller switches to waiting mode and a flashing line „wait“ appears on the DIALOG-DISPLAY (LCD). The start time and actual time are permanently indicated on the display.

### 8.3.1. Interrupting a profile

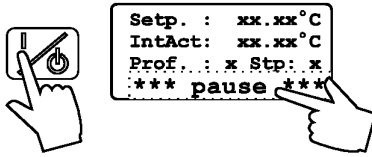

#### Interrupting a profile:

Press the start/stop key  to interrupt or restart a profile. The setpoint and time period set for the corresponding section are thus stopped at the values presently achieved. The programmable controller is put on hold and the message „pause“ flashes on the DIALOG DISPLAY (LCD).

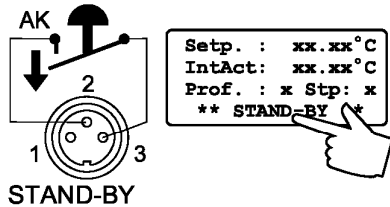

- A profile can be interrupted or restarted by an external emergency shut-off.(see page 36).

#### CAUTION:

**This is not an actual emergency shut-off!**

- The setpoint control and the timer are interrupted by breaking the contact “AK”. The programmer switches to the waiting position, while displaying this condition with a blinking LCD display.

#### Important:

To achieve this, the Stand-by condition must first be activated and the Autostart function turned on. (see page 19).



#### Warning:



Following a power interruption, it would be possible in this condition for the programmer to restart automatically. The safety and warning functions of the programmer should always be used to their fullest capacity.

See warning page 19

#### Termination of a profile:

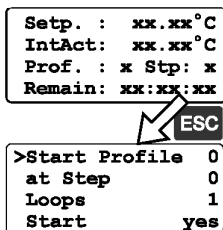
A profile can be terminated by pressing the escape key . The programmer switches back to the Start menu.



- Press escape  again to leave the menu or use the cursor keys   to remain in the Start menu.

The execution of another temperature profile can now be prepared if necessary.

## 8.4. Integrated programmer

The integrated programmer allows any desired temperature program sequences to be realized. Such a temperature sequence is called profile. A profile consists of individual sections defined by duration (t:) and target temperature. Target temperature is the setpoint (T:), that is achieved at the end of a section. The programmer uses time and temperature difference values within a section to calculate a temperature ramp.

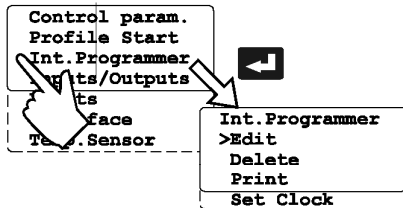

- Press enter to select the submenu „Int. Programmer“.
- Use de up/down cursor keys to select the desired option. Then press enter to open.  
A flashing segment indicates that a number or value needs to be entered.

<b>Edit</b>	Compile profiles
	Display sections
<b>Delete</b>	Delete sections
<b>Print</b>	Print a programmed profile
<b>Set clock</b>	Set the real time on the programmable controller

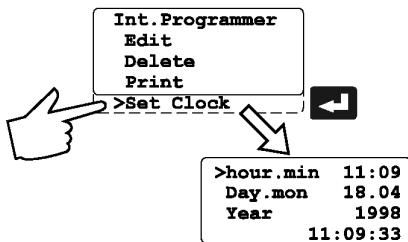

### Setting the clock

The integrated clock provides the flexibility to start a profile at any date and time. The clock is preset at the JULABO factory.

- Lines 1 to 3:  
Check for correctness of the preset date and time and correct if necessary.

The time is diplayed permanently in line 4.

Examples:



- Use the numerals to set time, date and year and set each entry with enter .



- Press escape to return to the previous menu level.



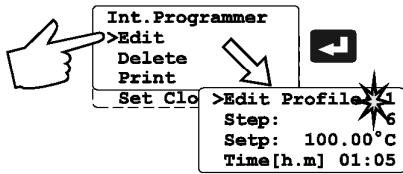

## Edit

### Compile profiles:

- A flashing segment indicates that a number needs to be entered. Under submenu „Edit Profile“ enter a profile number. Six profiles may be stored (nos. 0 to 5).
- Then programme the desired values for each section. Use the keypad to set section number, target temperature and time period. Set each entry with enter

Examples:

Profile No. 1

Step

Setpoint

Time

When the program is running, only sections having complete information for target temperature and time period are considered.

It makes sense, to leave out section numbers in the profile, in order to use them later for corrections in the profile.

### Important:

If a time of 00:00 is set for a profile, the profile is continued with the next section only after the setpoint temperature ( $\pm 0.2$  °C) is reached.

- Press escape to return to the previous menu level.

Example:

Step	(No.)	1	3	5	6	9	11	14
Setpoint	(°C)	50	50	100	100	80	80	20
Time	(h:m)	00:08	00:02	00:10	01:05	00:10	00:05	00:30

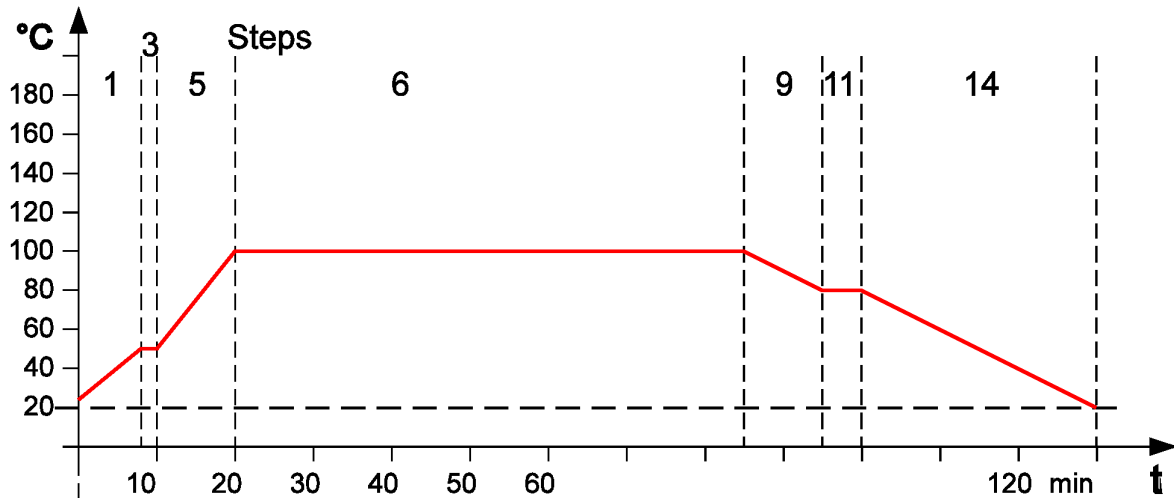

Step

```

Edit Profile: 1
>Step: 3
Setp: 50.00°C
Time[h.m] 00:02
  
```

### Display sections:

- Use the cursor keys to select the submenu „Step“, enter the desired number and press enter .
- The values previously set are displayed.

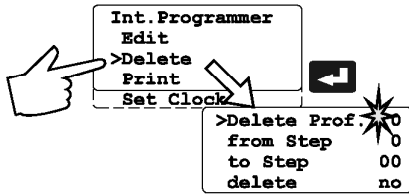

**Delete**

- A flashing segment indicates that the respective profile number needs to be entered in which one or more consecutive sections are to be deleted.
- In lines 2 and 3 of the DIALOG DISPLAY (LCD) enter the numbers of the sections to be deleted. Press enter

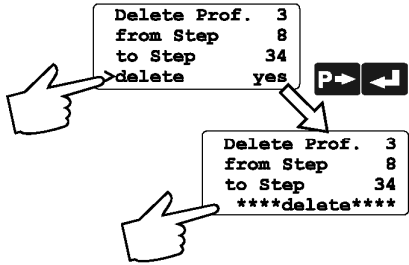

- **delete no / yes**  
Press the P-key to select the parameter „yes“ and press enter . Line 4 indicates the deletion.

Example:

Delete section 8 to section 34 in profile 3.

- Press escape to return to the previous menu level.

**Print**

Each profile may be printed via the serial interface for control or documentation.

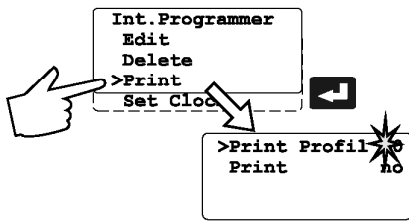

- A flashing segment indicates that the number of the profile to be printed needs to be entered.

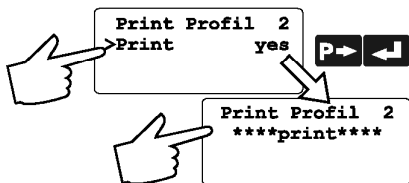

- **Print no / yes**  
Press the P-key to select the parameter „yes“ and press enter .

Printing is indicated in line 2.

Profile 1

Step 0	not defined!	
Step 1	50	00:08
Step 2	not defined!	
Step 3	50	00:02
Step 4	not defined!	
Step 5	100	00:10
Step 6	100	01:05
Step 7	not defined!	
Step 8	not defined!	
Step 9	80	00:10
Step 10	not defined!	
Step 11	80	00:05
Step 12	not defined!	
Step 13	not defined!	
Step 14	20	00:30
Step 15	not defined!	
	etc.	

This printing example shows the profile given as example on page 25.

## 8.5. Analog inputs/outputs

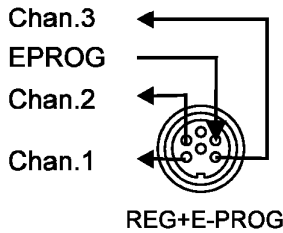

This submenu enables setting of the input and output values for the programmer input and the temperature recorder outputs of socket REG+E-PROG (21).

- Press enter to select the inputs/outputs submenu.
- Use the up/down cursor keys to select the desired option and press enter to open.

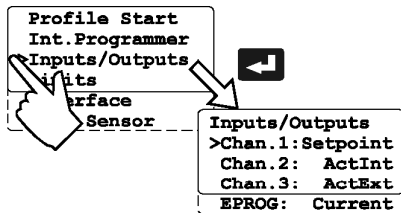

- Chan.1** voltage output for recorder (V)
- Chan.2** voltage output for recorder (V)
- Chan.3** current output for recorder (mA)
- EPROG** external programmer input

First define the desired output value for channels 1 to 3:

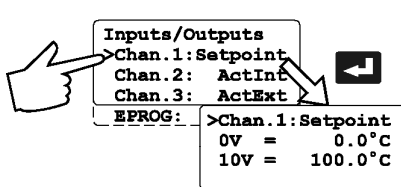

Press the P-key to select the desired output value and set with enter .

- Setpoint** active setpoint temperature (T1, T2, integr. programmer/ext. programmer)
- ActInt** internal actual temperature value (bath temperature)
- ActExt** external actual temperature value (external sensor)
- Power** periodic or intermittent heating or cooling

- Then select the display size for channels 1 to 3:

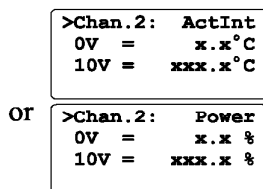

### Channel 1 and 2 voltage outputs

Assign the voltage values of 0 V to the lowest and 10 V to the highest necessary temperature or power rating required as an output value (°C or %).

### Current output channel 3

Assign the current values 0 mA or 4 mA to the lowest and 20 mA to the highest temperature or power rating required as an output value (°C or %).

The current output offers 2 ranges for selection: 0 to 20 mA and 4 to 20 mA.

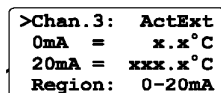

Select the desired range by pressing the P-key .

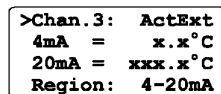

and set with enter .

The LCD display changes automatically.

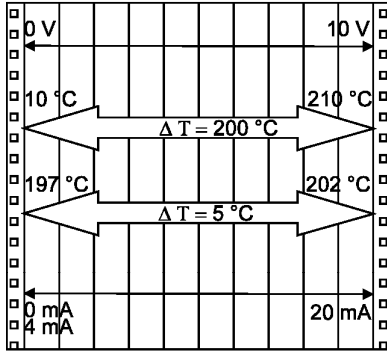

**Examples:**

lowest temperature value: 10 °C  
 highest temperature value 210 °C  
 Fig. shows 200 °C scaled to paper width  
 rise: 50 mV/°C

lowest temperature value: 197 °C  
 highest temperature value: 202 °C  
 Fig. shows 5 °C scaled to paper width  
 rise: 2000 mV/°C

```
>EPROG: Current
L Value 0.0°C
H Value 300.0°C
ExtSet 50.0°C
```

**EPROG - Input**

This input is necessary when the nominal value is to be determined and set by an external programmer.

Connect the external programmer to socket (21) REG+E-PROG of the programmable controller.

- The programmer input of the programmable controller can be matched to the output signal of the external programmer.

**Voltage**            voltage input  
**Current**            current input

Select the desired input value with the P-key **P→** and set with enter **↵**.

- **„L Value“ - Setting the LOW value:**  
 Adjust and set the lowest desired working temperature on the programmer (e.g. 0 °C).  
 Enter this same temperature on the programmable controller by pressing the appropriate buttons on the keypad and press enter **↵** to set.
- **„H Value“ - Setting the HIGH value:**  
 Adjust and set the highest desired working temperature on the programmer (e.g. 300 °C).  
 Enter this same temperature on the programmable controller by pressing the appropriate buttons on the keypad and press enter **↵** to set.
- Return to the standard display by pressing escape **ESC**.

```

>EPROG: Current
L Value 0.0°C
H Value 300.0°C
ExtSet 50.0°C

```

**ESC 3X**

```

EPROG : 50.00°C
IntAct: 50.00°C
Power: 50 %
Control: intern

```

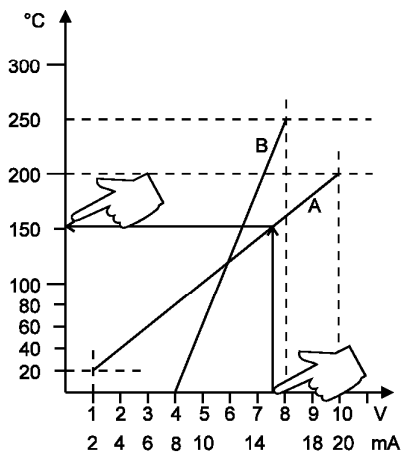

```

>EPROG: Current
L Value 20.0°C
H Value 200.0°C
ExtSet 152.0°C

```

**ESC 3X**

```

EPROG : 152.00°C
IntAct: 50.00°C
Power: 100 %
Control: intern

```

**Example:**

- Setting a temperature of 50 °C on the external programmer!

The value adjusted and set on the external programmer is displayed in line 4 of the DIALOG-DISPLAY (LCD) for control purposes (Example: ExtSet: 50.0 °C).

After returning the LCD display to standard display by pressing escape **ESC** („Setpoint“ - see page 18) this value is displayed in line 1 (Example: EPROG 50.00 °C).

This EPROG input enables the use of different voltage and current values as program parameters.

- „L Value“ - Setting the LOW value:

- 1) Adjust and set the lowest desired value on the voltage or current source resp. (Example A: 1 V).

- 2) Assign a lower temperature threshold value to this adjusted voltage/current value by pressing the appropriate buttons on the keypad of the programmable controller

(Example A: 20 °C ) and set by pressing enter .

- „H Value“ - Setting the HIGH value:

- 1) Adjust and set the highest desired value on the voltage or current source resp. (Example A: 10 V).

- 2) Assign an upper temperature threshold value to this adjusted voltage/current value by pressing the appropriate buttons on the keypad of the programmable controller

(Example A: 200 °C) and set by pressing enter .

- Return to the standard display by pressing escape **ESC**.

Example B in the diagram serves to illustrate that the end point values are freely selectable.

**Example out of diagram A:**

- Adjusting the voltage source for an output of 7.6 V!

Line 4 of the DIALOG-DISPLAY (LCD) shows the externally set setpoint value. The programmable controller calculates this value from the rise angle of the two predecided end points (in example A: 7.6 V correspond to an external setpoint temperature of 152.0 °C ).

After returning the LCD display to standard display by pressing escape **ESC**, this value is displayed in line 1 (Example: EPROG 152.00 °C).



**If this adjustment is not correctly performed at two different points, the setpoint setting will be incorrect.**

## 8.6. Limits

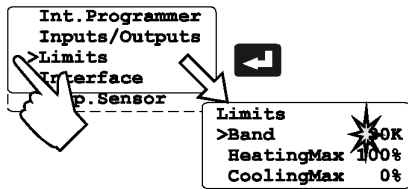

When operating the programmable controller under external control, band limiting is active. The preset value determines the maximum temperature difference between the internal bath and the external load. This adjustment possibility prevents sensitive equipment and temperature devices from damage.

Heating and cooling power of the programmable controller are adjustable.

100 % corresponds to the values in the technical specifications of the equipment.

- Select the submenu „Limits“ with enter
- Select the desired option with the up/down cursor keys .

A flashing digit indicates that a value needs to be entered.

**Band** 0 to 200 °C  
**HeatingMax** 0 to 100 % in steps of 1 %  
**CoolingMax** 0 to 100 % in steps of 1 %

- To set the newly entered value press enter .
- To return to the previous menu level press escape .

## 8.7. Interface

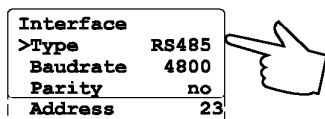
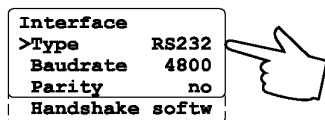
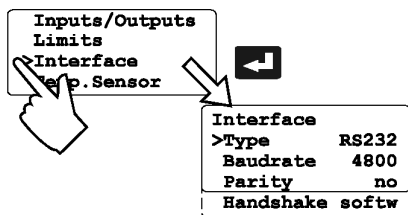

The interface parameters are set by selecting the submenu „Interface“ on the programmable controller. Normally, this is a one-time-only adjustment.

- Press enter to select the submenu „Interface“.
- Select the desired option with the up/down cursor keys . Enter the desired value for the flashing digit.

**Type** RS232 / RS485  
**Baudrate** 2400/4800/9600  
**Parity** none/even/odd  
**Handshake** software handshake/hardware handshake

**Address** 0 to 127

- Press the P-key to select the desired parameter and set with enter .
- Return to the previous menu level with escape .

## 8.8. Sensors

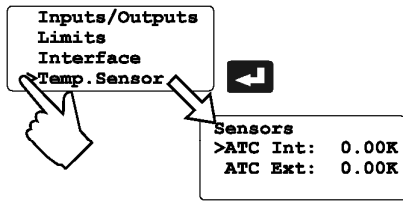

### ATC - Absolute Temperature Calibration

- Select the submenu „Temp.Sensor“ with enter
- Select the desired option with the up/down cursor keys . A flashing digit indicates that a value needs to be entered i.e. set.  
ATC Int.: used during the configuration of a Pt100 sensor attached on the socket labeled “INT”.
- ATC Ext.: used during the configuration of a Pt100 sensor attached on the socket labeled “EXT”.
- Setpoint range for internal or external calibration:  $\pm 9.99\text{ }^{\circ}\text{C}$ .
- Enter the desired correction value and set this value by pressing ENTER .

Thermometer ( $T_M$ )

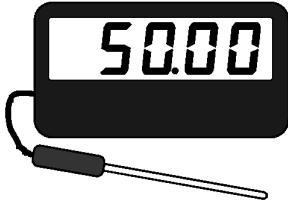

Programmable controller ( $T_L$ )

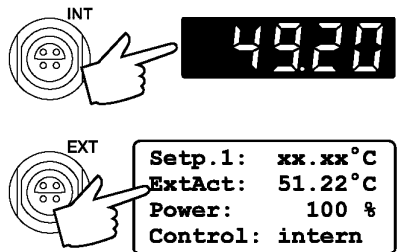

```
Sensors
>ATC Int: 0.80K
ATC Ext: -1.22K
```

Example:

1. Immerse temperature sensors individually or together in a calibration bath at  $50^{\circ}\text{C}$ , for example, and allow the reading to stabilize.
2. Both temperature values are displayed simultaneously on the controller readout:  
on the MULTI-DISPLAY:  
 $49.20^{\circ}\text{C}$  for temperature sensor attached to the socket labeled “INT”.  
on DIALOG-DISPLAY:  
 $51.22^{\circ}\text{C}$  for temperature sensor attached to the socket labeled “EXT”.
3. Calculate the temperature difference between the programmable controller ( $T_L$ ) and the thermometer ( $T_M$ ) ( $\text{change in } T = T_M - T_L$ ) and enter the correction value as the ATC parameter.
4. For ATC Int, enter the correction value (for example  $0.80\text{ }^{\circ}\text{C}$ ) with the keypad. Confirm entry with the Enter key .
- 5.
6. For ATC Ext, enter the correction value, (for example  $-1.22\text{ }^{\circ}\text{C}$ ) followed by the Enter key .
7. Return to standard display with the Escape key .

## 9. Troubleshooting guide / Error messages

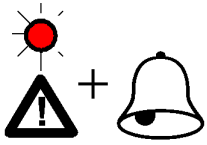

Whenever the microprocessor electronics registers a failure, a complete shutdown of the heating device is performed.

The alarm light "▲" illuminates and a continuous signal tone sounds.



- Cable of the working temperature sensor interrupted or short-circuited.

- Other errors

- Error in A/D converter.

- Safety sensor defect.
- The safety temperature value lies below the working temperature setpoint.  
Set the safety temperature to a higher value.





- External control selected, but external Pt100 sensor „EXT“ not connected.

- Heating circuit interrupted.

- Heating circuit short-circuited or interrupted.

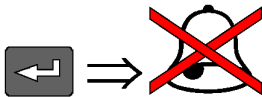
- Defective alarm relay.



- Press enter  to quit the audible signal.

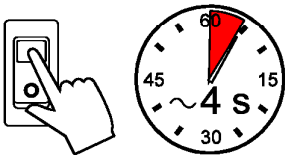

- After eliminating the malfunction, press the mains power switch off and on again to cancel the alarm state.

If the unit cannot be returned to operation, contact an authorized JULABO service station.





### Fuses

- The mains fuses on the rear of the unit may easily be exchanged as shown on the left.
- Fine fuses 230 V, T16 A or M1.25 A, dia. 5 x 20 mm  
115 V, T12.5 A or M2.5 A, dia. 5 x 20 mm



**Only use fine fuses with a nominal value as specified.**

## 10. Safety recommendations

Follow the safety recommendations to prevent damage to persons or property. Further, the valid safety instructions for working places must be followed.



- Connect the unit only to a grounded mains power socket!
- Observe the flash point of the bath medium used.  
The excess temperature protection should be set at least 25 °C below the fire point.
- Set the heating device according to the instructions prior to connection to the controller and ensure secure attachment to the bath.  
Danger of burning and fire!
- Immerse both temperature sensors in the bath medium and ensure secure attachment.
- Observe the limited working temperature range when using plastic bath tanks.
- Before cleaning the unit, disconnect the power plug from the mains socket.

## 11. Electrical connections

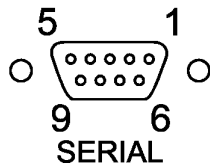

### RS232/RS485 serial interface (30)

This port can be used to connect a computer with an RS232 or RS485 cable for remote control of the programmable controller.

#### Pin assignments: RS232

Pin 2	RxD	Receive Data
Pin 3	TxD	Transmit Data
Pin 5	0 VD	Signal GND
Pin 6	DTR	Data terminal ready
Pin 7	RTS	Request to send
Pin 8	CTS	Clear to send

#### Pin assignments: RS485

Pin 3	A	
Pin 5	0 VD	Signal GND
Pin 8	B	
Pins 1, 2, 4, 6, 7, 9		Reserved - do not use!

#### Interface correspondence: RS232:

Programmable controller		Computer
9-pole plug		9-pole socket
Pin 2 RxD	↔	Pin 3 TxD
Pin 3 TxD	↔	Pin 2 RxD
Pin 4 DTR	↔	Pin 6 DSR
Pin 5 GND	↔	Pin 5 GND
Pin 7 RTS	↔	Pin 8 CTS
Pin 8 CTS	↔	Pin 7 RTS

RS232 interface cable 9-pin / 9-pin, 2.5 m -  
Order No.: 8 980 073



**Use shielded cables only.**

### Programmer input / temperature recorder output (31)

Analog inputs / outputs see page 27

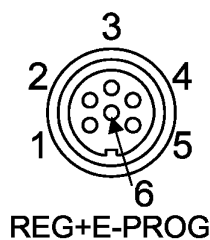

Pin		Signal
1	Voltage output	Channel 1 0 ... 10 V
2	Voltage output	Channel 2 0 ... 10 V
3	GND for outputs	0 V
4	Programmer input	EPROG 0 to 10 V / 0 to 20 mA
5	Current output	Channel 3 0 to 20 mA / 4 to 20 mA
6	GND for Programmer	0 V



**Use shielded cables only.**

### \* Control output (32)

The \* connector may be used for control of JULABO refrigerated programmable controllers or as output for alarm messages.

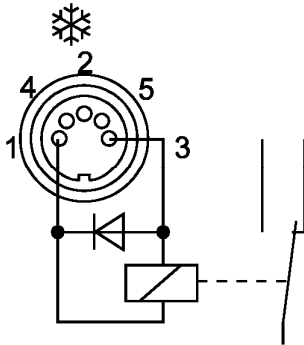

Pin assignment:

Pin	Signal
1	+24 V (I max. current 25 mA)
2	0 V
3	Alarm relay
4	Reserved - do not use!
5	Cooling pulse

Circuit:	Operation	= relay powered
	Alarm	= relay not powered



**Use shielded cables only.**

### Alarm output (34)

(for external alarm signal)

This potential-free change-over contact is activated in case of an alarm when pins 2 and 3 are connected.

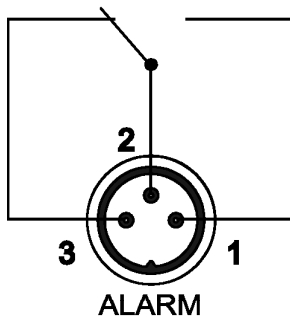

Switching capacity	max.	30 W / 40 VA
Switching voltage	max.	125 V~/–
Switching current	max.	1 A



**Use shielded cables only.**

### Socket for temperature sensors (19, 20, 21)

Pin assignment:

Pin	Signal
1	Current+
2	Voltage+
3	Voltage-
4	Current-

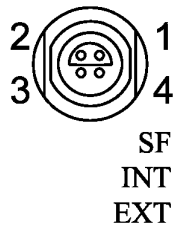

**Use shielded cables only.**

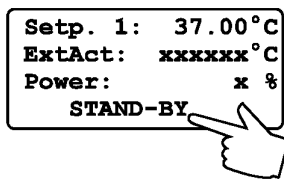
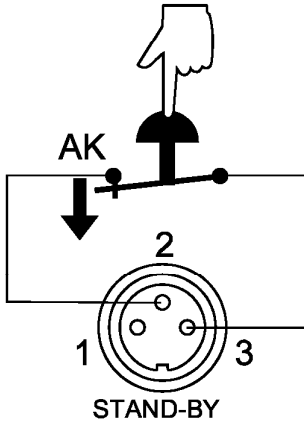

**STAND-BY input (33)** (for external emergency switch-off)

Pin assignment:	Pin	Signal
	1	not connected
	2	5 V / DC
	3	0 V

**Use shielded cables only.**

Activate the stand-by input:

- Under menu item Stand-by, set the parameter to „yes“ (see page 19).
- Connect an external contact 'AK' (e.g. for emergency switch-off) or an alarm contact of the superordinated system.
- If the connection between Pin 2 and Pin 3 is interrupted by opening the contact 'AK', a complete shutdown of the heating device is effected, and the unit enters the condition "OFF".  
As long as the contact remains open, line 4 of the DIALOG-DISPLAY (LCD) flashes and displays the message „STAND-BY“.

If the contact is reclosed, the programmable controller returns to standby mode and “OFF” is displayed.

**Additional tips for using the stand-by command:**

The stand-by function can be used in conjunction with the autostart feature (see page 19).

1. If the autostart function is not turned on, the stand-by input should be used as described above.
  2. If the autostart function is enabled, the instrument will revert back to the original method of entering the setpoint (i.e. keypad, RS232, analog input, etc.).
- Entering the setpoint with the keypad, for example T1. As described above, a bipolar shut-down is accompanied by the “STAND-BY” display and the OFF status. The programmable controller starts again when the contact is reclosed. The temperature of the bath liquid changed during the STAND-BY status.
  - Entering the setpoint with the programmer (see pages 21 and 23). The display STAND-BY appears. The setpoint value and the time are both held at the current value. The temperature of the bath fluid will be held constant at this temperature. The programmer continues once the contact is reclosed.

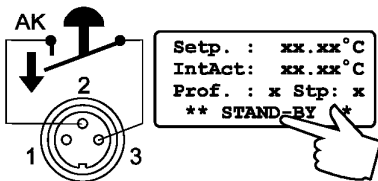

**⚠ CAUTION:**

**This is not an actual emergency shut-off!**

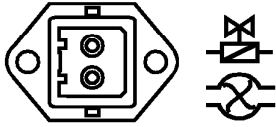

### Control connector (35)

The connector may be used with solenoid valves.

Line voltage: 230 V~ / max. 1.25 A  
115 V~ / max. 2.5 A

## 12. Remote control

### 12.1. Setup for remote control



Select the „Configuration“ submenu and select the option „Setpoint“ to define the interface (see page 18).

The interface parameters are set by selecting the submenu „Interface“ on the programmable controller. Normally, this is a one-time-only adjustment. (Selecting and setting menu items, see page 30.)

#### Factory settings:

##### RS232

BAUDRATE	4800 bauds
PARITY	even parity
HANDSHAKE	Protocol RTS/CTS (hardware handshake)
	Data bits 7
	Stop bit 1



**Like all parameters which can be entered through the keypad, interface parameters are stored in memory even after the programmable controller is turned off.**

### 12.2. Communication with a PC or a superordinated data system

Suitable terminal programs for communicating with a PC are:

- MS-Windows - TERMINAL.EXE (included with MS-Windows).
- MS-DOS - Procomm Plus, Datastrom Technologies.
- MS-DOS - Norton Utilities.



If the programmable controller is put into remote control mode via the configuration level, the display will read "r OFF" = REMOTE STOP.

The programmable controller is now operated via the computer.

In general, the computer (master) sends commands to the programmable controller (slave). The programmable controller sends data (including error messages) only when the computer sends a query.

A transfer sequence consists of:

- address (RS485 interface only)
- command
- space (↔; Hex: 20)
- parameter (the character separating decimals in a group is the period)
- end of file (↵; Hex: 0D)

The commands are divided into **in** or **out** commands.

**in** commands: asking for parameters to be displayed

**out** commands: setting parameters



The **out** commands are valid only in remote control mode.

When the RS485 interface is used, the three-digit instrument address stands in front of each command.

(example: address Ad32 = **A032**)

**Examples:**

Command to set the working temperature T1 to 55.5 °C

**out\_sp\_00 ↔ 55.5↵**

**A032\_out\_sp\_00 ↔ 55.5↵**

Command to ask for the working temperature T1:

**in\_sp\_00↵**

**A032\_in\_sp\_00↵**

Response from the programmable controller:



**55.5↵**

**A032\_55.5↵**

### 12.3. List of commands

When the RS485 interface is used, the instrument address stands in front of each command (Axxx\_).

**in-commands:** Asking for parameters or temperature values to be displayed.



Command	Parameter	Response of programmable controller
<b>version</b>	none	Number of software version (V X.xx)
<b>status</b>	none	Status message, error message (see page 42)
<b>in_pv_00</b>	none	Actual bath temperature.
<b>in_pv_01</b>	none	Heating power being used (%).
<b>in_pv_02</b>	none	Temperature value registered by the external Pt100 sensor.
<b>in_pv_03</b>	none	Temperature value registered by the safety sensor.
<b>in_sp_00</b>	none	Working temperature "T1"
<b>in_sp_01</b>	none	Working temperature "T2"
<b>in_sp_03</b>	none	High temperature warning limit "  ".
<b>in_sp_04</b>	none	Low temperature warning limit "  ".
<b>in_sp_05</b>	none	Setpoint temperature of the external programmer (socket - REG+E-PROG) .
<b>in_hil_00</b>	none	Max. cooling power (%).
<b>in_hil_01</b>	none	Max. heating power (%).
<b>in_mode_01</b>	none	Selected working temperature: 0 = "T1". 1 = "T2".
<b>in_mode_02</b>	none	Identification type: 0 = no identification 1 = single identification 2 = continual identification

<b>in-commands:</b> Asking for parameters or temperature values to be displayed.
--

Command	Parameter	Response of programmable controller
<b>in_mode_03</b>	none	Type of the programmer input: 0 = Voltage 0 V to 10 V 1 = Current 0 mA to 20 mA
<b>in_mode_04</b>	none	Internal/external temperature control: 0 = Temperature control with Pt100 sensor „INT“. 1 = Temperature control with Pt100 sensor „EXT“.
<b>in_mode_05</b>	none	Circulator in Stop/Start condition: 0 = Stop 1 = Start
<b>in_par_01</b>	none	Time constant of the external bath.
<b>in_par_02</b>	none	Internal slope.
<b>in_par_03</b>	none	Time constant of the internal bath.
<b>in_par_04</b>	none	Band limiting (max. difference between the temperatures in the internal bath and external system).
<b>in_par_05</b>	none	Ratio for max. cooling power versus max. heating power.
<b>in_par_06</b>	none	Xp control parameter of the internal controller.
<b>in_par_07</b>	none	Tn control parameter of the internal controller.
<b>in_par_08</b>	none	Tv control parameter of the internal controller.
<b>in_par_09</b>	none	Xp control parameter of the cascade controller.
<b>in_par_10</b>	none	Proportional portion of the cascade controller.
<b>in_par_11</b>	none	Tn control parameter of the cascade controller.
<b>in_par_12</b>	none	Tv control parameter of the cascade controller.



**out commands:** Setting parameters or temperature values.

Command	Parameter	Response of circulator
out_mode_01	0	Use working temperature "T1"
out_mode_01	1	Use working temperature "T2"
out_mode_02	0	No identification. Temperature control by using the stored parameters.
out_mode_02	1	Single identification of controlled system after the next start.
out_mode_02	2	Continual identification of controlled system whenever a new setpoint is to be reached.
out_mode_04	0	Temperature control with Pt100 sensor „INT“.
out_mode_04	1	Temperature control with Pt100 sensor „EXT“.
out_mode_05	0	Stop the programmable controller = r OFF.
out_mode_05	1	Start the programmable controller.
out_sp_00	xxx.x	Set working temperature "T1".
out_sp_01	xxx.x	Set working temperature "T2".
out_sp_03	xxx.x	Set high temperature warning limit  .
out_sp_04	xxx.x	Set low temperature warning limit  .
out_hil_00	xxx	Set the desired maximum cooling power (0 % to 100 %). This adjustment is required only for proportionally controlled refrigerated circulators.
out_hil_01	xxx	Set the desired maximum heating power (10 % to 100 %).



**out commands:** Setting parameters or temperature values.

Command	Parameter	Response of programmable controller
<b>out_par_04</b>	xxx	Band limiting during external control. Setting the maximum difference between the temperatures in the internal bath and external system.
<b>out_par_05</b>	xxx	Ratio for max. cooling power versus max. heating power (0...0.99).
<b>out_par_06</b>	xxx	Xp control parameter of the internal controller.
<b>out_par_07</b>	xxx	Tn control parameter of the internal controller.
<b>out_par_08</b>	xxx	Tv control parameter of the internal controller.
<b>out_par_09</b>	xxx	Xp control parameter of the cascade controller.
<b>out_par_10</b>	xxx	Proportional portion of the cascade controller.
<b>out_par_11</b>	xxx	Tn control parameter of the cascade controller.
<b>out_par_12</b>	xxx	Tv control parameter of the cascade controller.

#### 12.4. Status messages / error messages

The programmable controller sends data (including error messages) only when the computer sends a query.

Status messages	Description
00 MANUAL STOP	Programmable controller in "OFF" state.
01 MANUAL START	Programmable controller in keypad control mode.
02 REMOTE STOP	Programmable controller in "r OFF" state.
03 REMOTE START	Programmable controller in remote control mode.

Error messages	Description
<b>-02 REFRIGERATOR ALARM</b>	Control cable of the refrigerated circulator or MVS solenoid valve controller short-circuited or interrupted.
<b>-03 EXCESS TEMPERATURE WARNING</b>	High temperature warning "  ".
<b>-04 LOW TEMPERATURE WARNING</b>	Low temperature warning "  ".
<b>-05 WORKING SENSOR ALARM</b>	Working temperature sensor short-circuited or interrupted.
<b>-07 I<sup>2</sup>C-BUS ERROR</b>	Internal error when reading or writing the I <sup>2</sup> C bus.
<b>-08 INVALID COMMAND</b>	Invalid command.
<b>-09 COMMAND NOT ALLOWED IN CURRENT OPERATING MODE</b>	Invalid command in current operating mode.
<b>-10 VALUE TOO SMALL</b>	Entered value too small.
<b>-11 VALUE TOO LARGE</b>	Entered value too large.
<b>-12 TEMPERATURE MEASUREMENT ALARM</b>	Error in A/D converter.
<b>-13 WARNING : VALUE EXCEEDS TEMPERATURE LIMITS</b>	Value lies outside the adjusted range for the high and low temperature warning limits. But value is stored.
<b>-14 TEMPERATURE/LEVEL ALARM</b>	Safety temperature alarm 
<b>-15 EXTERNAL SENSOR ALARM</b>	External control selected, but external Pt100 sensor not connected.
<b>-16 TRIAC/RELAY CONNECTION OPEN</b>	Heating circuit interrupted.
<b>-17 TRIAC SHORTED</b>	Heating circuit short-circuited.
<b>-18 RELAY SHORTED</b>	Defective alarm relay.

### 13. Cleaning the unit



**Before cleaning the unit, disconnect the power plug from the mains socket!**

Clean the outside of the programmable controller using a wet cloth and low surface tension water.



**Prevent humidity from entering into the programmable controller.**

### 14. Maintenance

The programmable controller is designed for continuous operation under normal conditions. Periodic maintenance is not required.

#### Repairs

**Before asking for a service technician or returning a JULABO programmable controller for repair, please contact an authorized JULABO service station.**

When returning a unit, take care of careful and adequate packing. JULABO is not responsible for damages that might occur from insufficient packing.



**JULABO reserves the right to carry out technical modifications with repairs for providing improved performance of a unit.**

---

## 15. Technical specifications

		LC6
Adjustable temperature range	°C	-100 ... 400
Display accuracy	%	±0.5 ±1Digit
Temperature stability	°C	>±0.03
Temperature selection via keypad		digital indication on DIALOG-Display (LCD)
remote control via personal computer		indication on monitor
Temperature indication		MULTI-DISPLAY (LED) DIALOG-DISPLAY (LCD)
Resolution	°C	0.01
Absolute Temperature Calibration		
ATC INT	°C	±9.99
ATC EXT	°C	±9.99
Temperature control		ICC - Intelligent Cascade Control, self tuning parameters for control and modification
Electrical connections:		
Computer interface RS232 or RS485		
Programmer input		0 to 10 V / 0 to 20 mA
Temperature recorder outputs	Channel 1 / 2	0 to 10 V
	Channel 3	0 to 20 mA / 4 to 20 mA
Stand-by input		
External alarm device		24 to 0 V DC / max. 25mA
Safety sensor „SF“		Pt100, 4-lead technique
Measurement and control sensor „INT“		Pt100, 4-lead technique
Measurement and control sensor „EXT“		Pt100, 4-lead technique
Control connector for solenoid valve		230 V / max. 1.25 A
Mains power socket for heating device		max. 3000 W; resistive load
Ambient temperature	°C	5 ... 40
Mains power connection ±10 %	V/ Hz	230 / 50
Total power consumption	W	3100
Overall dimensions (WxDxH)	cm	21 x 18 x 18
Weight	kg	4

---

All measurements have been carried out at:

mains voltage: 230 V / 50 Hz

ambient temperature: 20 °C

Technical changes without prior notification reserved.

Safety installations according to IEC 61010-2-010:

Excess temperature protection adjustable from 0 °C ... 420 °C

Supplementary safety installations

High temperature warning function optical + audible (in intervals)

Low temperature warning function optical + audible (in intervals)

Supervision of the working sensor plausibility control

Alarm indication optical + audible

Standards:

EMC regulations EN 61326

Guideline for first voltage range EN 61010-1, EN 61010-2-010

Environment:

Use only indoor.

Altitude up to 2000 m - normal zero.

Ambient temperature: +5 ... +40 °C (for storage and transportation)

Air humidity acc. DIN EN 61 010, part 1:

Max. rel. humidity 80 % for temperatures up to +31 °C,

linear decrease down to 50 % rel. humidity at a temperature of +40 °C

Protection class: IP 31 acc. EN 60 529

Power supply: acc. to class 1, VDE 0106 T1

**not for use in explosive atmosphere**

Max. mains fluctuation of  $\pm 10$  % are permissible.

Overvoltage category II

Pollution degree 2

---

## 16. EC Declaration of Conformity



The following unit complies with the essential safety requirements outlined by the EC Directives concerning the guidelines for electromagnetic compatibility (89/336/EEC) and for the low voltage regulations (73/23/EEC).

**Programmable Controller LC6**

This unit is manufactured in compliance with the following guidelines

electrical equipment for control technology and laboratory application –  
EMC requirements outlined by  
**EN 61326**

safety regulation for electrical devices for measuring, control and  
laboratory application specified by  
**EN 61010**

**Julabo**

Julabo Labortechnik GmbH  
Eisenbahnstr. 45  
D-77960 Seelbach / Germany

A handwritten signature in black ink, appearing to read 'G. Juchheim'.

G. Juchheim, Managing Director

## 17. Warranty conditions

JULABO Labortechnik GmbH warrants its products against defects in material or in workmanship, when used under appropriate conditions and in accordance with appropriate operating instructions

**for a period of ONE YEAR.**

**Extension of the warranty period – free of charge**



With the '1PLUS warranty' the user receives a free of charge extension to the warranty of up to 24 months, limited to a maximum of 10 000 working hours.

To apply for this extended warranty the user must register the unit on the JULABO web site [www.julabo.de](http://www.julabo.de), indicating the serial no. The extended warranty will apply from the date of JULABO Labortechnik GmbH's original invoice.

JULABO Labortechnik GmbH reserves the right to decide the validity of any warranty claim. In case of faults arising either due to faulty materials or workmanship, parts will be repaired or replaced free of charge, or a new replacement unit will be supplied.

Any other compensation claims are excluded from this guarantee.